











USER MANUAL

MA601

Body Composition Analyzer

Explanation of Graphic Symbols on Label/Packaging

Text/Symbol	Meaning
	Caution, consult accompanying documents before use.
	Separate collection for waste of electrical and electronic equipment, in accordance with Directive 2002/96/EC. Do not dispose of device with everyday waste.
	Name and address of device manufacturer, and year/country of manufacture.
	Carefully read user manual before installation and usage, and follow instructions for use.
	Medical electrical device, Type BF applied part.
REF	Device catalogue number / model number.
EC REP	Name and address of authorized representative in the European Union.
MD	Device is a medical device. Text indicates device category type.
LOT	Manufacturer's batch or lot number for device.
SN	Device's serial number.
UDI	Device's Unique Device Identifier.
e	Value in mass units (verified models only). This is the difference between two consecutive display values, used to classify and verify a scale.
	Device conforms to 93/42/EEC as amended by 2007/47/EC Medical Device Directive. Four digit number refers to Notified Body.
	Name and address of entity importing device (if applicable).
	Name and address of entity responsible for translating Information For Use (if applicable).
	Device's Taiwan NCC approval number.
	Device conforms to U.S. Federal Communications Commission regulations.

NOTE

After the MA601 has been turned on, the screen will remain dark for about 10 seconds. This is normal, and the device will continue with self-calibration process.

Copyright Notice**Charder Electronic Co., Ltd.**

No.103, Guozhong Rd., Dali Dist.,

Taichung City 41262 Taiwan

Tel: +886-4-2406 3766

Fax: +886-4-2406 5612

Website: www.chardermedical.com

E-mail: info_cec@charder.com.tw

Copyright© Charder Electronic Co., Ltd. All rights reserved.

This user manual is protected by international copyright law. All content is licensed, and usage is subject to written authorization from Charder Electronic Co., Ltd. (hereinafter Charder) Charder is not liable for any damage caused by a failure to adhere to requirements stated in this manual. Charder reserves the right to correct misprints in the manual without prior notice, and modify the exterior of the device for quality purposes without customer consent.



Charder Electronic Co., Ltd. No. 103, Guozhong Rd., Dali Dist.,
Taichung City, 41262 Taiwan

CONTENTS

I. SAFETY NOTES	4
A. General Information	4
B. Precaution Symbols	6
EMC guidance and manufacturer's declaration	7
II. INTRODUCTION TO THE MA601 BODY COMPOSITION ANALYZER	11
III. INSTALLATION	12
A. Contents	12
B. Environment	13
C. Installation Instructions	14
IV. EXTERIOR AND PANEL DEFINITION	17
V. GETTING STARTED	20
A. Power Supply	20
B. Start Screens	21
VI. INSTRUCTIONS FOR OPERATION	23
VII. MEASURING INSTRUCTIONS	25
A. Measuring Posture	25
B. Proper Measurement Posture (feet)	27
C. Proper Measurement Posture (hands)	28
D. Measuring Procedure	29
VIII. ABOUT RESULTS	35
A. Standard Result Sheet	35
B. Result Sheet Explanation	36
IX. SYSTEM SETTINGS	45
X. PRINTING	56
A. Printer Compatibility	56
B. Connecting Printer	56
C. Configure Printer Settings in the device	57
XI. TROUBLESHOOTING	59
XII. FREQUENTLY ASKED QUESTIONS(FAQs)	60
XIII. PRODUCT SPECIFICATIONS	63

I. SAFETY NOTES

A. General Information

Thank you for choosing this Charder Medical device. It is designed to be easy and straightforward to operate, but if you encounter any problems not addressed in this manual, please contact your local Charder service partner. Before beginning operation of the device, please read this user manual carefully, and keep it in a safe place for reference. It contains important instructions regarding installation, proper usage, and maintenance.

Intended purpose

This medical device is designed to be used in accordance with national regulations, to estimate body composition within specifications, for body composition-related usage by professionals.

Clinical Benefit

Measurement results can be used by professionals to monitor body composition-related issues.

Contraindications

During measurement, this machine will send a low level imperceptible electrical current throughout the body. Individuals with implanted medical devices, such as:

1. Pacemakers
2. Electronic lungs and other electronic medical life support equipment
3. ECG devices

must not use this machine, as the electric current may affect the implanted device, endangering lives.

Warning: To avoid electric shock, this device should be plugged into a grounded electrical outlet

Caution : General Handling

- This device is intended for indoor use only.
- Do not place the device on slippery surfaces.
- Ensure all parts are properly locked and tightened before operating the device.
- Device is intended to measure one subject at a time.

Electric Shock

- Do not touch the power supply with wet hands.
- Do not crimp the power cable, and avoid sharp edges.
- Do not overload extension cables connected to the device.
- Route the network and power cable carefully, to avoid tripping.
- Keep the device away from liquids

Caution : Injuries and Infections

- Ensure that subjects do not have wounds or contagious diseases on the palms of their hands or the soles of their feet.
- For hygiene purposes, Charder recommends cleaning the measuring platform after each measurement with a soft cloth and alcohol.
- Ensure that the measuring platform is dry before usage.



I. SAFETY NOTES

Caution : Maintenance

- Device does not require routine user maintenance. However, regular checking of accuracy is recommended; frequency to be determined by level of use and state of device, or local metrology/measuring instrument regulations if applicable. If results are inaccurate, please contact local distributor.

Caution

Preventing Device Damage

- Please contact your local Charder distributor for regular maintenance and calibration.
- This device does not contain any user-maintained parts. All maintenance, technical inspections, and repairs should be conducted by an authorized Charder service partner, using original Charder accessories and spare parts. Charder is not liable for any damages arising from improper maintenance or usage. Dismantlement of the device will void the warranty.
-  Take care to make sure fluids do not enter the device, as they may damage the internal electronics.
- Switch off the device before disconnecting the power supply.
-  Do not place the device in direct sunlight, or in close proximity to an intense heat source. Excessively high temperatures may damage the internal electronics.
-  Strong cleaning agents can damage the measuring platform's surface.
Alcohol wipes can be used to clean the electrodes and weighing platform.
Alcohol-based cleaning solutions should not be used on the touch screen.
- The device has an expected service life of 5 years when correctly handled, serviced, and periodically inspected in accordance with manufacturer's instructions.

Caution

Usage of Results







- The MA601 is not a diagnostic device. Results should be interpreted with assistance from a professional.
- BIA results are calculated based on impedance values validated with representative population studies and statistical analysis. As such, the technique is best suited for tracking progress for an individual over a period of time, or for categorizing large groups of people, rather than used as a one-time analysis. Accuracy of results is highly dependent on proper measurement procedure. For more information on getting the best results, please see Chapter VI.
(INSTRUCTIONS FOR OPERATION)

Incident Reporting

- Any serious incident that has occurred in relation to the device should be reported to the manufacturer, EU representative (if device is used in EU member state), and competent authority of user/subject's member state.

I. SAFETY NOTES

B. Precaution Symbols

 Warning	Identifies the possibility of serious injury or death for the user if the device is mishandled, or safety instructions are not followed.
 Caution	Identifies the possibility of physical injury or device damage if the device is mishandled, or safety instructions are not followed.
	The caution symbol indicates general precautions that should be taken when using the device.
NOTE	Additional information regarding the operating environment, conditions for installation, or special conditions in usage.
	Indicates helpful hints and supplementary information.
	Indicates actions that should not be performed.
Bold	Bold text identifies buttons on the display panel or computer screen.
	Hazard icon warning against possible electric shock.

I. SAFETY NOTES

EMC guidance and manufacturer's declaration

Guidance and manufacturer's declaration-electromagnetic emissions		
The Body Composition Analyzer MA601 is intended for use in the electromagnetic environment specified below. The customer or the user of the Body Composition Analyzer MA601 should assure that it is used in such an environment.		
Emission test	Compliance	Electromagnetic environment-guidance
RF emissions CISPR 11	Group 1	The Body Composition Analyzer MA601 uses RF energy only for its internal function. Therefore, its RF emissions are very low and are not likely to cause any interference in nearby electronic equipment.
RF emissions CISPR 11	Class B	The Body Composition Analyzer MA601 is suitable for use in all establishments, including domestic establishments and those directly connected to the public low-voltage power supply network that supplies buildings used for domestic purposes.
Harmonic emissions IEC 61000-3-2	Class A	
Voltage fluctuations /flicker emissions IEC 61000-3-3	Compliance	

I. SAFETY NOTES

Guidance and manufacturer's declaration-electromagnetic immunity			
<p>The Body Composition Analyzer MA601 is intended for use in the electromagnetic environment specified below. The customer or the user of the Body Composition Analyzer MA601 should assure that it is used in such an environment.</p>			
Immunity test	IEC 60601 test level	Compliance level	Electromagnetic environment-guidance
Electrostatic discharge(ESD) IEC 61000-4-2	± 8 kV contact ± 2 kV, ± 4 kV, ± 8 kV, ± 15 kV air	± 8 kV contact ± 2 kV, ± 4 kV, ± 8 kV, ± 15 kV air	Floors should be wood, concrete or ceramic tile. If floors are covered with synthetic material, the relative humidity should be at least 30%
Electrical fast transient/burst IEC 61000-4-4	±2kV for power supply lines ±1kV for input/output lines	±2kV for power supply lines ±1kV for input/output lines	Mains power quality should be that of a typical commercial or hospital environment.
Surge IEC 61000-4-5	+ 1kV line(s) to line(s) + 2kV line(s) to earth	+ 1kV line(s) to line(s) + 2kV line(s) to earth	Mains power quality should be that of a typical commercial or hospital environment.
Voltage Dips, short interruptions and voltage variations on power supply input lines IEC 61000-4-11	0% UT for 0,5 cycle 0% UT for 1 cycle 70% UT(30% dip in UT) for 25 cycles 0% UT for 5 s	0% UT for 0,5 cycle 0% UT for 1 cycle 70% UT(30% dip in UT) for 25 cycles 0% UT for 5 s	Mains power quality should be that of a typical commercial or hospital environment. If the user of the Body Composition Analyzer MA601 requires continued operation during power mains interruptions, it is recommended that the Body Composition Analyzer MA601 be powered from an uninterruptible power supply or a battery.
Power frequency (50, 60 Hz) magnetic field IEC 61000-4-8	30 A/m	30 A/m	The Body Composition Analyzer MA601 power frequency magnetic fields should be at levels characteristic of a typical location in a typical commercial or hospital environment.
<p>NOTE UT is the a.c. mains voltage prior to application of the test level.</p>			

I. SAFETY NOTES

Guidance and manufacturer's declaration-electromagnetic immunity			
The MA601 is intended for use in the electromagnetic environment specified below. The customer or the user of the MA601 should assure that is used in such and environment.			
Immunity test	IEC 60601 test level	Compliance level	Electromagnetic environment-guidance
Conducted RF IEC 61000-4-6	3 Vrms 150 KHz to 80 MHz 6 V in ISM bands between 0,15 MHz and 80 MHz 80 % AM at 1 kHz	3 Vrms 150 KHz to 80 MHz 6 V in ISM bands between 0,15 MHz and 80 MHz 80 % AM at 1 kHz	Portable and mobile RF communications equipment should be used no closer to any part of the Body Composition Analyzer MA601 including cables, then the recommended separation distance calculated from the equation applicable to the frequency of the transmitter.
Radiated RF IEC 61000-4-3	3 V/m 80MHz to 2,7 GHz	3 V/m 80MHz to 2,7 GHz	Recommended separation distance: $d = 1,2 \sqrt{P}$ $d = 1,2 \sqrt{P}$ 80MHz to 800 MHz $d = 2,3 \sqrt{P}$ 800MHz to 2,7 GHz Where P is the maximum output power rating of the transmitter in watts (W) according to the transmitter manufacturer and d is the recommended separation distance in meters (m).
			Field strengths from fixed RF transmitters, as determined by an electromagnetic site survey, ^a should be less than the compliance level in each frequency range. ^b
			Interference may occur in the vicinity of equipment marked with the following symbol: 
<p>NOTE1 At 80 MHz and 800 MHz, the higher frequency range applies.</p> <p>NOTE2 These guidelines may not apply in all situations. Electromagnetic propagation is affected by absorption and reflection from structures, objects and people.</p>			

I. SAFETY NOTES

- a Field strengths from fixed transmitters, such as base stations for radio (cellular/cordless) telephones and land mobile radios, amateur radio, AM and FM radio broadcast and TV broadcast cannot be predicted theoretically with accuracy. To assess the electromagnetic environment due to fixed RF transmitters, an electromagnetic site survey should be considered. If the measured field strength in the location in which the Body Composition Analyzer MA601 is used exceeds the applicable RF compliance level above, the Body Composition Analyzer MA601 should be observed to verify normal operation. If abnormal performance is observed, additional measures may be necessary, such as re-orienting or relocating the Body Composition Analyzer MA601
- b Over the frequency range 150 kHz to 80 MHz, field strengths should be less than 3 V/m.

Recommended separation distance between portable and mobile RF communications equipment and the MA601

The Body Composition Analyzer MA601 is intended for use in an electromagnetic environment in which radiated RF disturbances are controlled. The customer or the user of the Body Composition Analyzer MA601 can help prevent electromagnetic interference by maintaining a minimum distance between portable and mobile RF communications equipment (transmitters) and the Body Composition Analyzer MA601 as recommended below, according to the maximum output power of the communications equipment.

Rated maximum output power of transmitter W	Separation distance according to frequency of transmitter m		
	150 kHz to 80 MHz $d = 1,2\sqrt{P}$	80 MHz to 800 MHz $d = 1,2\sqrt{P}$	800 MHz to 2,7 GHz $d = 2,3\sqrt{P}$
0,01	0,12	0,12	0,23
0,1	0,38	0,38	0,73
1	1,2	1,2	2,3
10	3,8	3,8	7,3
100	12	12	23

For transmitters rated at a maximum output power not listed above, the recommended separation distance d in metres (m) can be estimated using the equation applicable to the frequency of the transmitter, where p is the maximum output power rating of the transmitter in watts (W) according to the transmitter manufacturer.

NOTE1 At 80 MHz and 800 MHz, the separation distance for the higher frequency range applies.

NOTE2 These guidelines may not apply in all situations. Electromagnetic propagation is affected by absorption and reflection from structures, objects and people.

II. INTRODUCTION TO THE MA601 BODY COMPOSITION ANALYZER

Trainers and athletes understand that fitness is much more than how you look and how much you weigh. Quantifying where the muscle is going. Seeing if the loss in weight is from burning through fat, or insufficient hydration. Tracking where progress has been made, and where to focus your efforts. The fitness community has asked for precise tools and data to keep up with increasingly advanced needs, and Charder is proud to present the MA601 Body Composition Analyzer, designed to assist professionals in elevating program quality and progress analysis. Body composition analysis was originally used primarily in the field for quantifying and measuring the fundamental makeup of the body. Bioelectrical Impedance Analysis (BIA) is a fast, simple, and non-invasive assessment of body composition with accurate results validated with widely acknowledged and accepted gold standards such as DXA.

The MA601 provides the relevant measurement values and data that you need to bring your program to the next level. Boasting multiple measurement frequencies and sophisticated algorithms, Charder stands by our devices with clinical trials and over ten years of original peer-reviewed scientific research, for results you can trust.

III. INSTALLATION

A. Contents

Unboxing accessories

- MA601 body composition analyzer
- Power adapter DC 12V, 5A, 60VA
- Power cord
- User manual

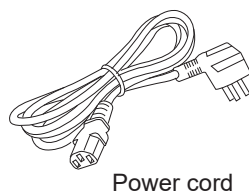
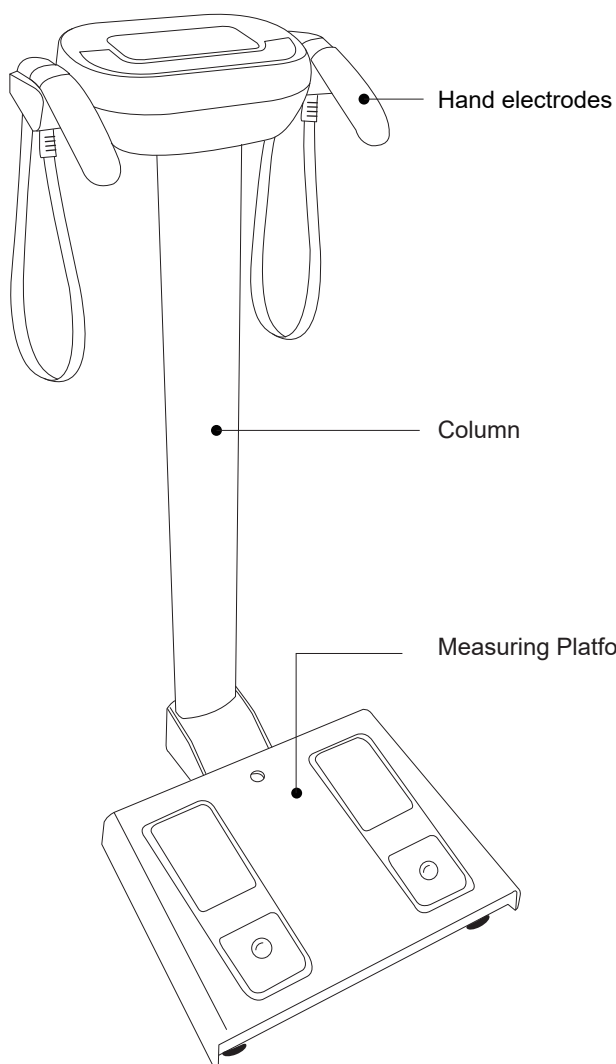

Power cord

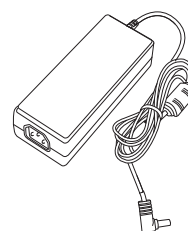

Power adapter

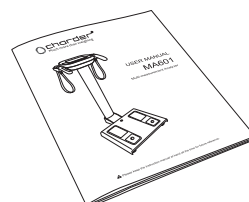

User manual

III. INSTALLATION

B. Environment

The device should be placed on a flat and hard surface. Usage on carpet may result in static electricity, which may damage the equipment and cause inaccuracies in measurement.

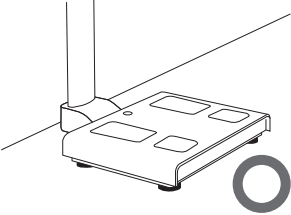
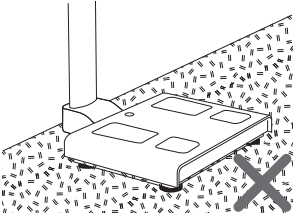
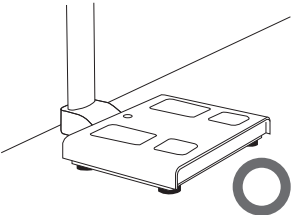
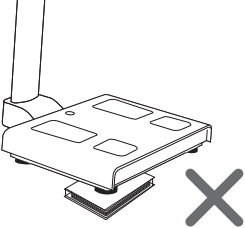
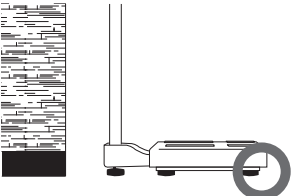
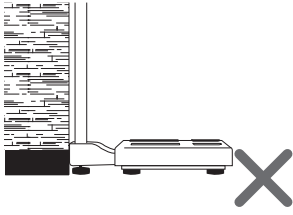
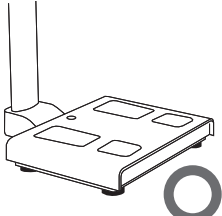
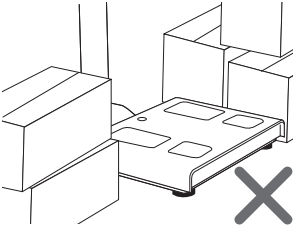
<p>placed on hard surface</p> 	<p>placed on carpet</p> 
<p>flat surface</p> 	<p>uneven surface</p> 
<p>keep space between the wall</p> 	<p>placed against the wall</p> 
<p>clear surroundings</p> 	<p>objects placed around the device</p> 

III. INSTALLATION

C. Installation Instructions

1. Open MA601 box
2. Remove user manual and power adapter from box

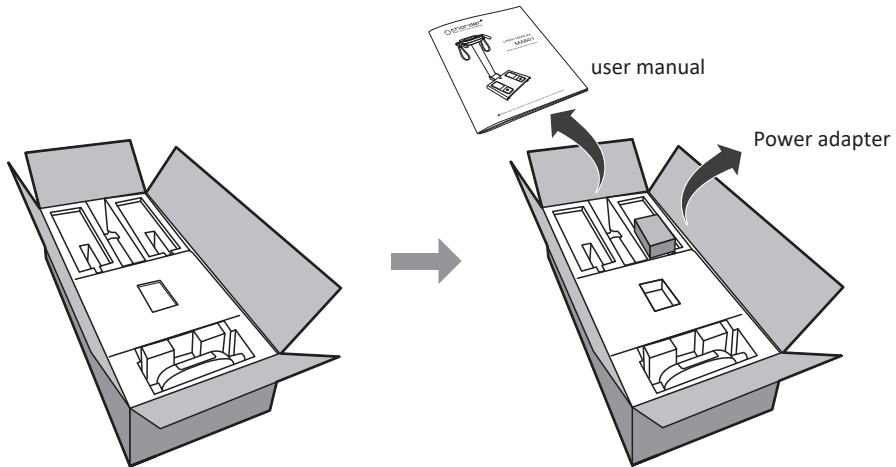

3. Remove polyethylene foam from box
4. Raise display column up into upright position

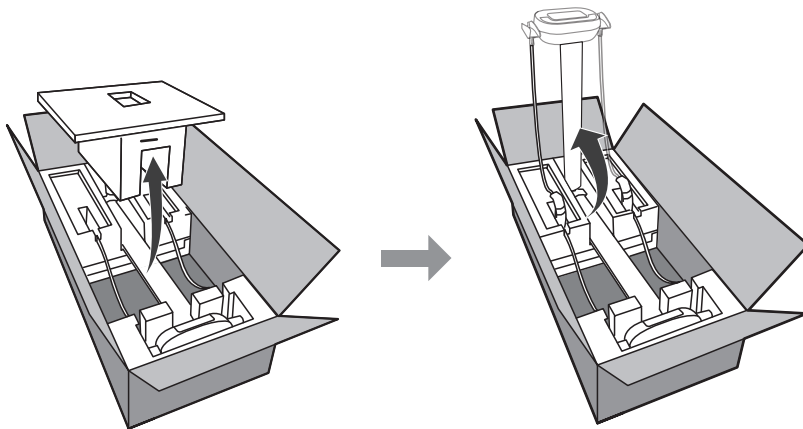

III. INSTALLATION

5. Take hand electrodes out from box and place them on hand electrodes holder on the display
6. Remove polyethylene foam from box

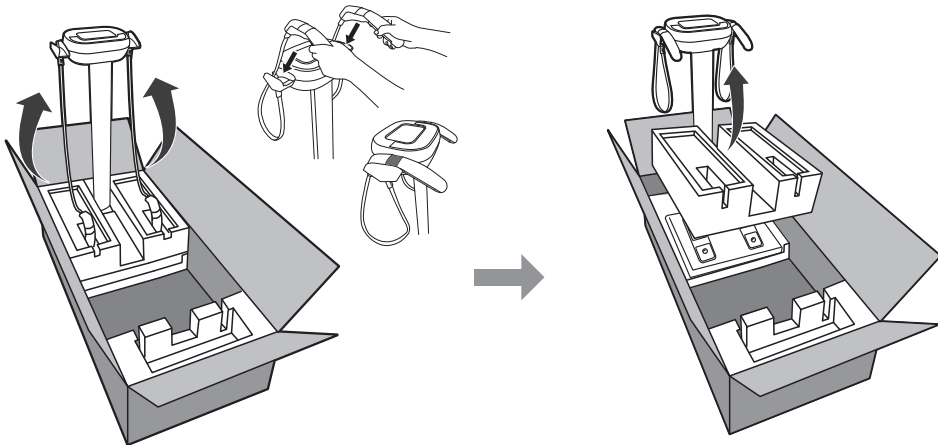

NOTE :

At least two people are needed to remove the MA601 from its box

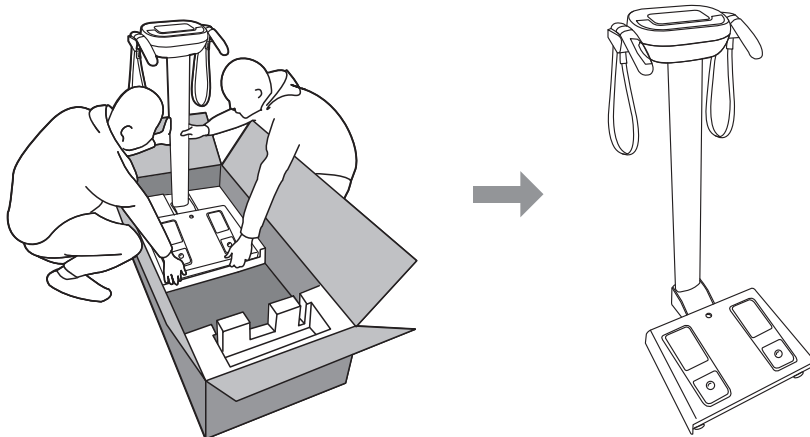

III. INSTALLATION

Use fastener to tighten column and base platform

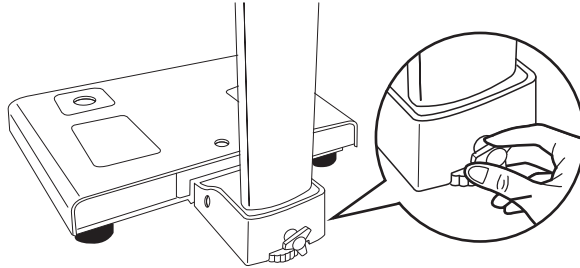

Plug 12V Charger power adapter in the jack.

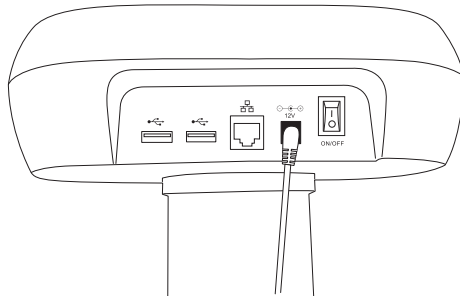

Turn power switch ON to start the device

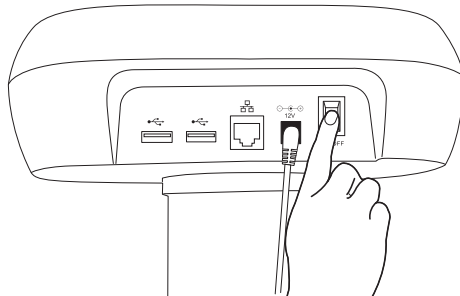

Bubble level adjustment instruction

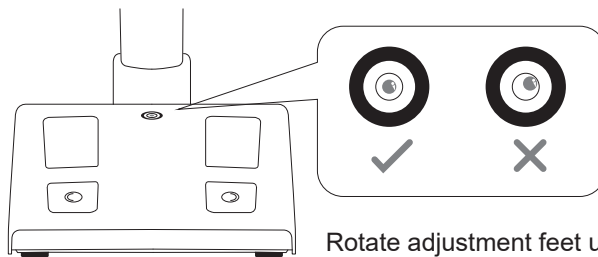

Rotate adjustment feet until bubble level is centered
(counter-clockwise to lower, clockwise to raise)

IV. EXTERIOR AND PANEL DEFINITION

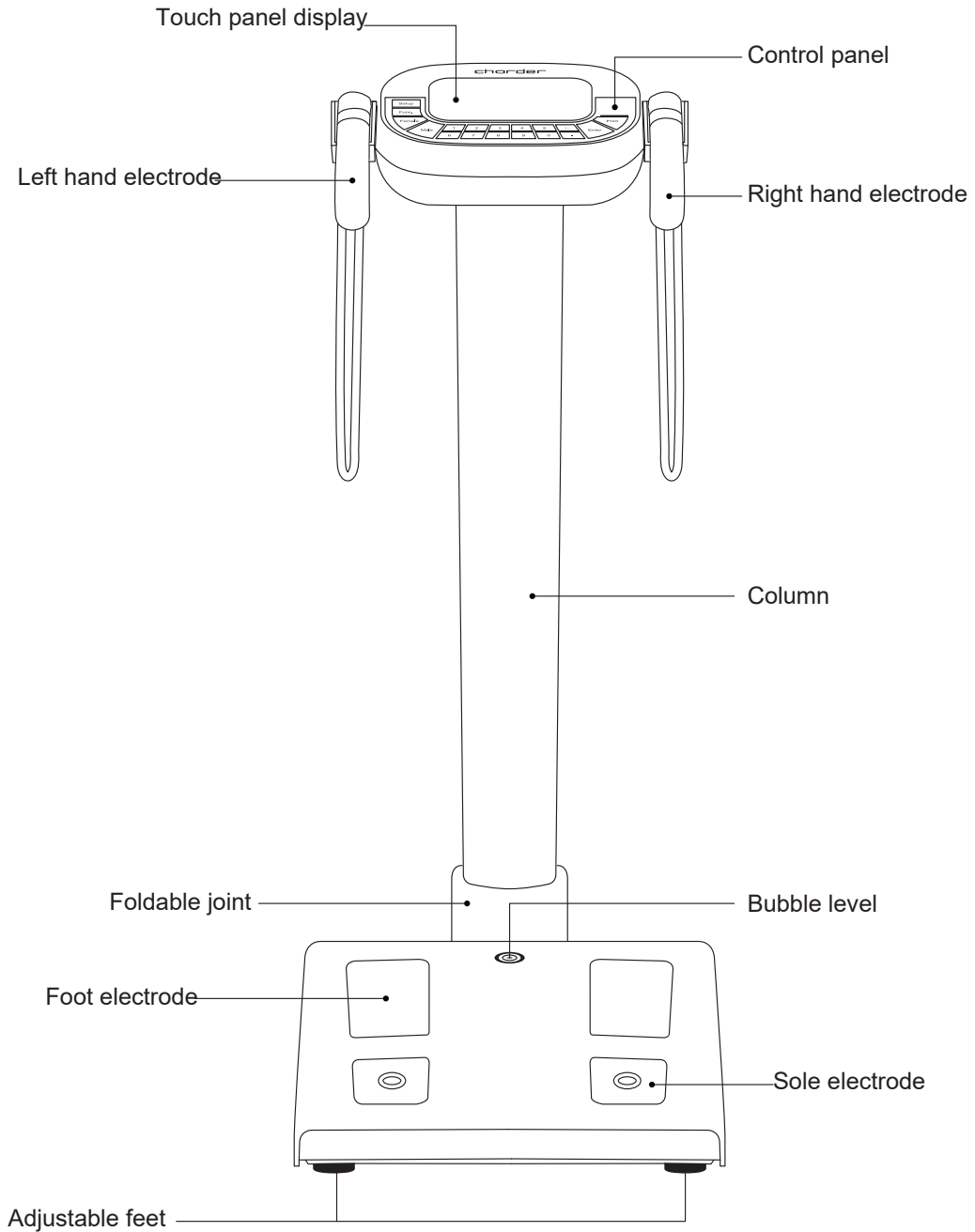

IV. EXTERIOR AND PANEL DEFINITION

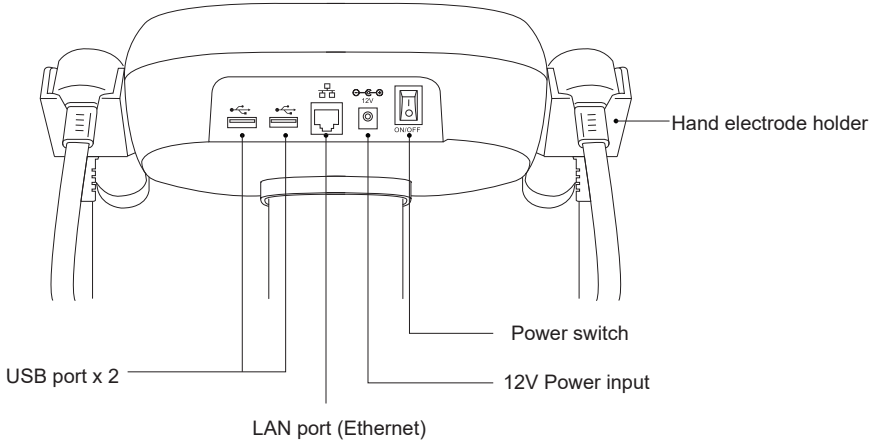
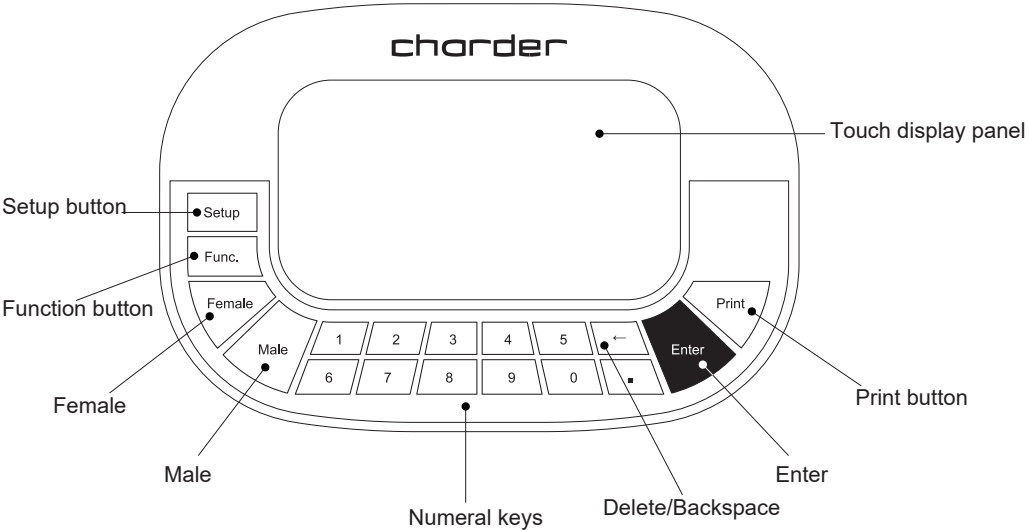

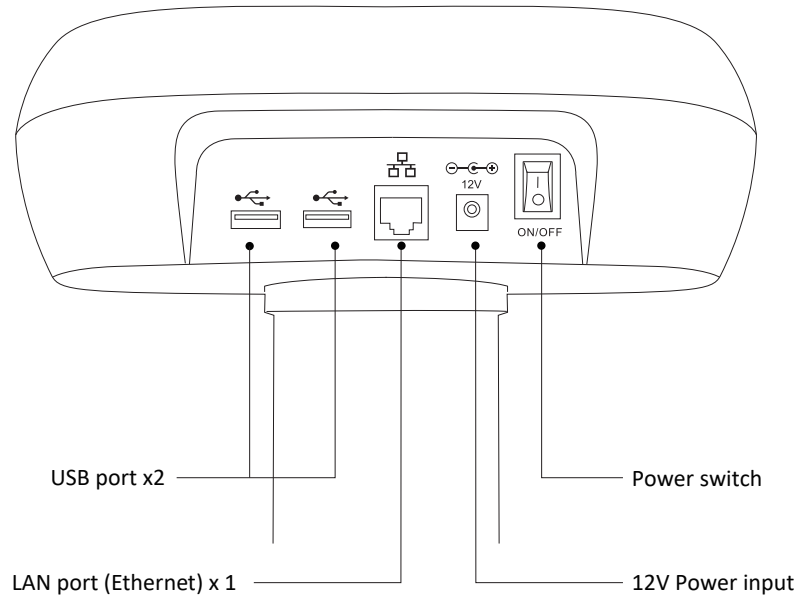

IV. EXTERIOR AND PANEL DEFINITION

Rear panel Instruction

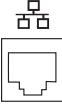

Rear panel definition

	USB port	For connecting to a printer, flash drive, or PC
	LAN port	For connecting the MA601 to a network
	Power jack plug	For connecting to a power adapter
	Power switch	For switching the MA601 on and off

V. GETTING STARTED



Always use the specified adapter provided by Charder. Using other adapters may result in device damage or inaccurate readings.

If the device is not plugged into a grounded outlet, electric surges may cause damage, or test results may be affected.

Electrical interference and instability may cause error in test results. Avoid installing the device near products that may create electrical interference.

A. Power Supply

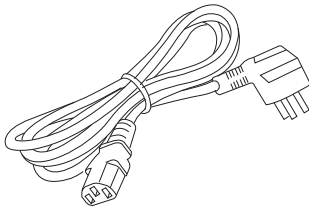

Power cord

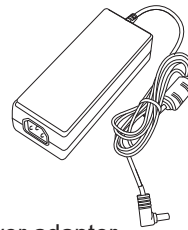

Power adapter

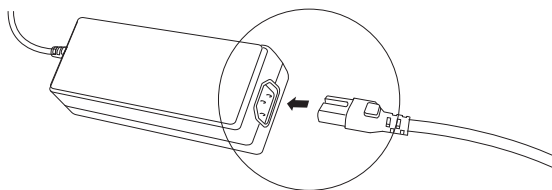

Plug power cord into the power adapter

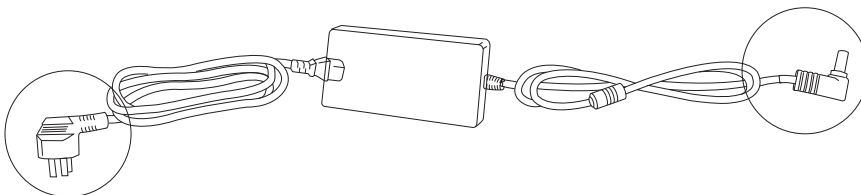

Plug into the mains

Plug into the 12V power input at rear of scale

V. GETTING STARTED

B. Start Screens

NOTE

After the MA601 has been turned on, the screen will remain dark for about 10 seconds. This is normal, and the device will continue with self-calibration process.

Press the ON/OFF switch on the back of the display panel to turn on device



The device will automatically run through several loading screens throughout the start-up process, as seen below.



V. GETTING STARTED

Charder continually upgrades its software in response to customer feedback and new research findings. The screen below displays the current software version.

This Body Composition Analyzer uses eight multi-frequency electrodes to conduct bioelectrical impedance analysis. Conforming to relevant safety and medical regulations, its accuracy has been validated through peer-reviewed studies and clinical trials, and can be used as a quick, convenient, non-invasive method of body composition analysis. Before using this device, please study the user manual carefully for operation instructions in order to receive best results.

A low level imperceptible electric current will be sent through the subject's body during measurement. The safety of the device used correctly in normal operating conditions has been proven. However, should the subject feel any discomfort in the measurement process, or the device appears to malfunction, users should stop operation immediately, and contact your local Charder distributor for further instructions. For safety purposes, this device should not be used by subjects with the following characteristics:

- *Life-sustaining electronic implants, e.g. artificial lungs
- *Electronic medical implants, e.g. cardiac pacemaker
- *ECG or other electronic medical devices

For safety purposes, if you are using this device to measure body composition for the purposes of sports therapy or weight loss, do not interpret and act on results without professional medical or fitness advice. If you have any questions or problems regarding usage of the device, please contact your local Charder distributor, or Charder Medical customer service.

During self-calibration, the measuring platform should be kept free of objects. No cables should be placed under the platform.

Running self-calibration,
keep platform free of object

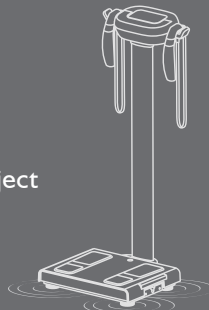

When system self-calibration is complete, the device is ready for measurements. You will see the start screen below.

2017/07/18 11:27 AM

Input new or registered user ID

ID 0/16

OK

Settings Measurement

VI. INSTRUCTIONS FOR OPERATION

Warning

Who should not use this device

Bioelectrical Impedance Analysis impedance measurements should not be used by subjects with the following characteristics:

(1) Electronic medical implants, e.g. cardiac pacemaker

A low level imperceptible electrical current will be sent through the body during measurement, which may damage the implanted device or result in malfunction.

(2) Prosthetics and amputation

BIA measures impedance measured using an electric current sent through the body through eight electrode contact points (two for each hand and two for each foot). As the current cannot flow through prosthetic limbs, measurement is not possible.

(3) Pregnant Women

BIA equations are created based on statistical analysis of sample populations. If subject's body composition differs significantly from these sample populations, equations derived from "normal" healthy adults will be inherently less accurate in these subjects. Women undergo a wide range of body composition changes during pregnancy, including but not limited to change in fat percentage and body water. Without dedicated algorithms, pregnant women should use results with caution and professional advice.

Measurement Rules

For best results, Body Composition Analysis should be conducted under specific controlled conditions. Inconsistent measuring conditions will affect the accuracy and validity of BIA results, and interpretation of body composition. The information below regarding the effect of various factors on measurement results is largely sourced from related research by Kushner et al¹. Before measurement, please take note of the following:

(1) Do not exercise or perform strenuous physical tasks before measurement.

Strenuous physical tasks and exercise can result in a temporary change in body composition measurements. As BIA analyzes electrical impedance in the body, activities that might affect impedance (e.g. increased perspiration, dehydration, blood circulation) may affect measurement accuracy.

(2) Affect of food and drink on measurement results.

Ingestion of food and drink can affect impedance and weight, and thus analysis results. This change generally lasts 2-5 hours after each meal. For most accurate results, BIA measurements should be conducted in a fasting state (e.g. before breakfast)².

Diuretics (e.g. caffeine, alcohol) can cause dehydration, creating an overestimation of body fat. For most accurate results, diuretics should be avoided prior to measurement.

1. Kushner RF, *Clinical characteristics influencing bioelectrical impedance analysis measurements*, 1996

2. R Gallagher, M & Walker, Karen & O'Dea, K. *The influence of a breakfast meal on the assessment of body composition using bioelectrical impedance*. *European journal of clinical nutrition*. 52. 94-7. 10.1038/sj.ejcn.1600520., 1998.

VI. INSTRUCTIONS FOR OPERATION

(3) Do not shower or bathe directly before measurement.

Perspiration can result in a temporary change in body composition measurements, as the accuracy of BIA depends largely upon interpretation of measured impedance values, which are affected greatly by hydration levels.

(4) Perform the measurement under normal temperature conditions (24-28°C)

Extreme temperatures (both hot and cold) can result in temporary physiological changes. For example, excessive sweating due to heat can cause increased impedance measurements, resulting in a higher fat calculation. For best results, measurements should be conducted in an environment between 24-28°C.

(5) Remove shoes and socks before measurement.

Shoes and socks will interfere with the electric current, making measurement inaccurate or in some cases, impossible.

(6) Avoid physical contact with other people during measurement.

Because BIA measures the impedance encountered as the electric current travels through the subject's body, if another individual is touching the subject, the electric current may pass through the other individual, causing inaccuracy in measurement results.

(7) Measure height accurately

Inaccurate height input will affect estimation of body composition.

(8) Perform the measurement in the morning.

As a general rule, BIA measurements should be performed in the morning to minimize the influence of activity throughout the day on measurements.

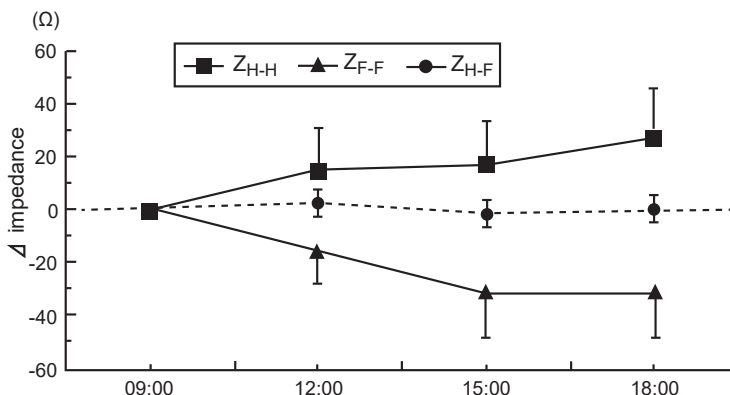

The chart above depicts changes in segmental impedance throughout the day, as reported by Oshima et al. (NOTE: ZH-H, ZF-F, and ZH-F refer to Hand-to-Hand, Foot-to-Foot, and Hand-to-Foot respectively.)³

3. Oshima Y & Shiga T. Within-day variability of whole-body and segmental bioelectrical impedance in a standing position, *European Journal of Clinical Nutrition* 2006, 60, 938-941

VII. MEASURING INSTRUCTIONS

A. Measuring Posture

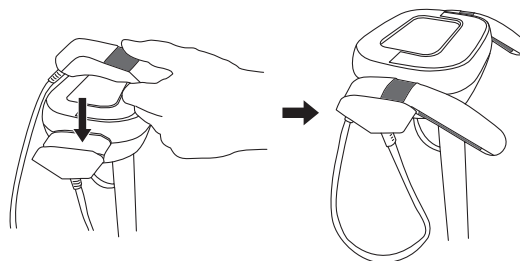
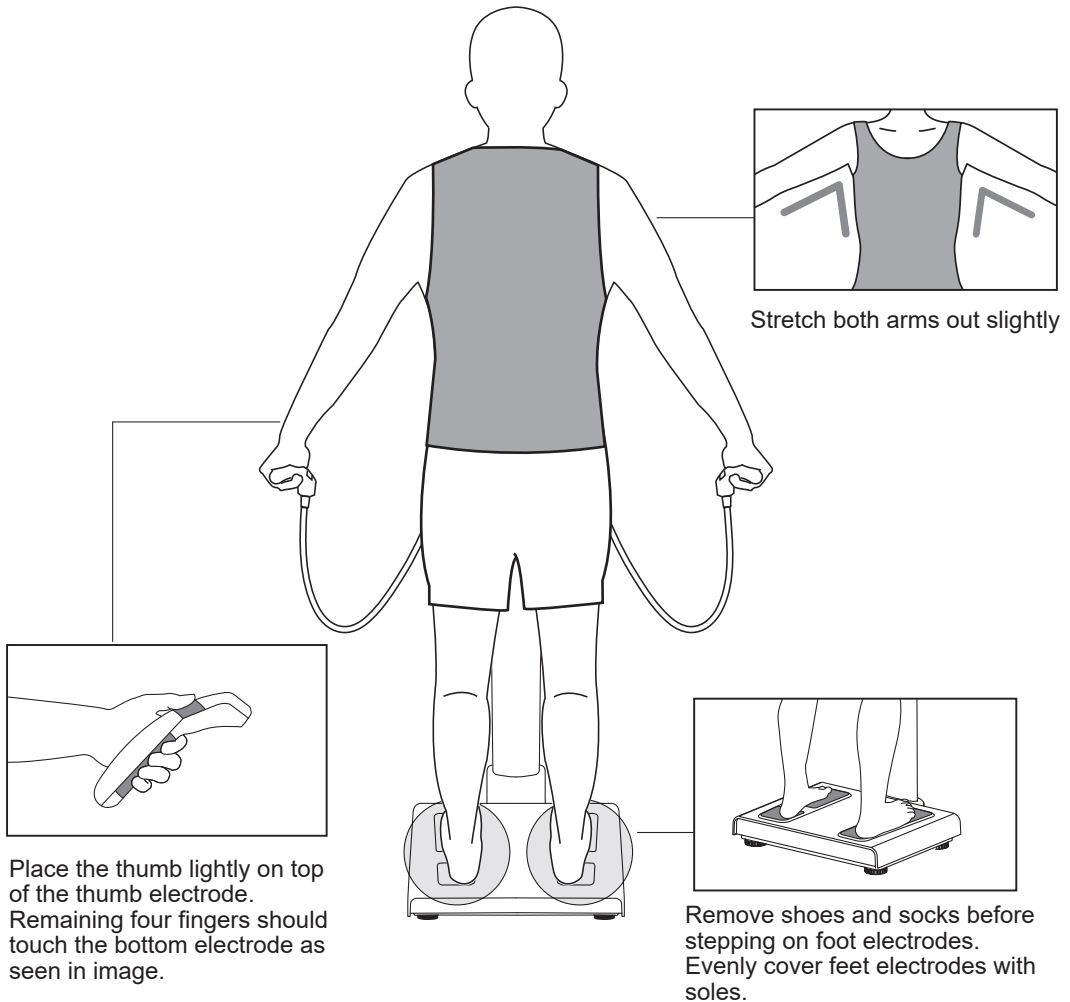

Hand electrodes should be placed back into holders after measurement is completed.

VII. MEASURING INSTRUCTIONS

NOTE :

Incorrect posture during measurement

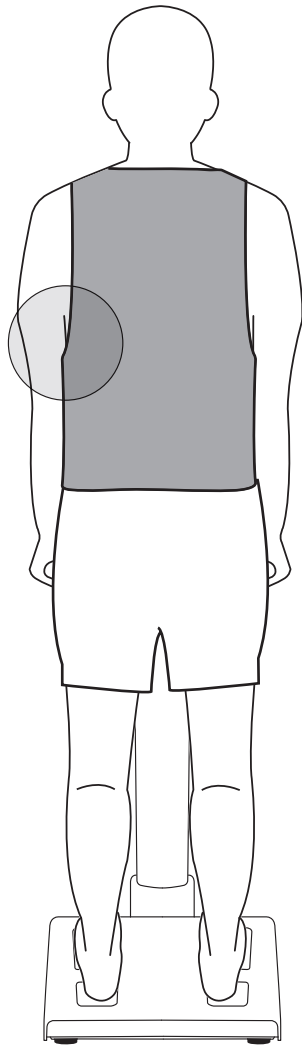

Arms placed against body

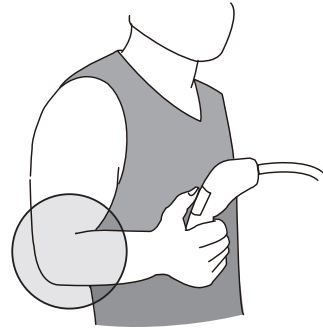

Arms bent



Movement during measurement

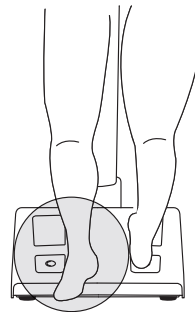

Leaving platform during measurement

VII. MEASURING INSTRUCTIONS

B. Proper Measurement Posture (feet)

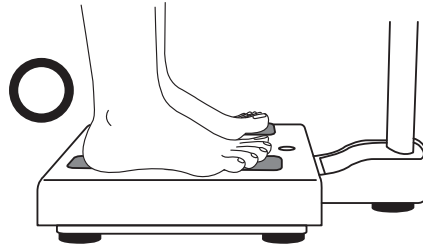

Correct foot placement



Incorrect foot electrode contacts

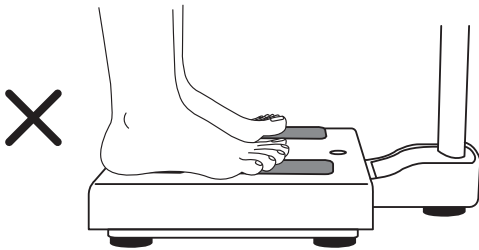

Feet are not in full contact with forward electrodes.

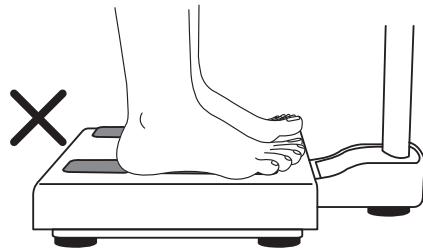

Feet are not in full contact with rear electrodes

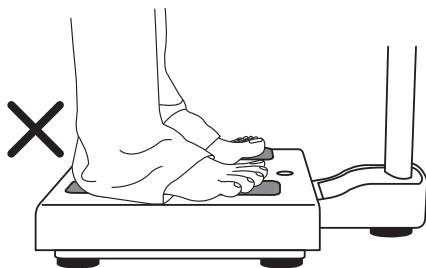

Heels are obstructed from full contact with rear electrodes due to clothing.

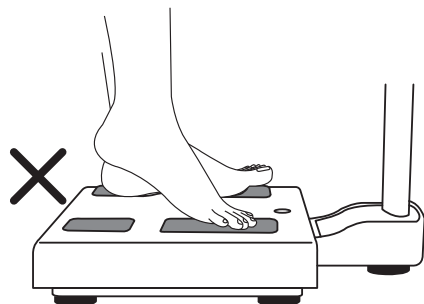

Incorrect foot electrode contact

C. Proper measurement procedure (hands)

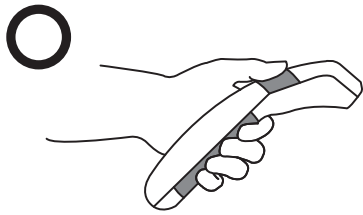

Correct hand electrode contact

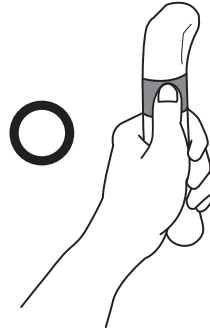

Correct hand electrode contact



Incorrect hand electrode contacts

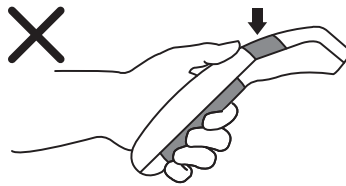

Thumb is not in contact with thumb electrode, remaining fingers are not in full contact with finger electrodes

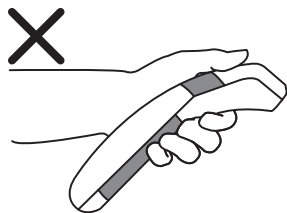

Thumb not in contact with thumb electrode

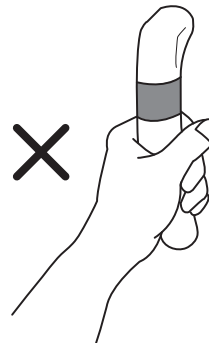

Thumb not in contact with thumb electrode

VII. MEASURING INSTRUCTIONS

D. Measuring Procedure

1. Enter a new or registered ID. If ID already exists, the user profile will be displayed for verification on the next page (skip to Step 6), press **OK** to proceed.

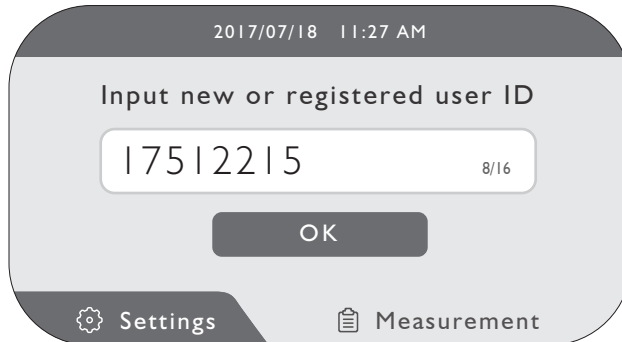

A screenshot of a mobile application interface. At the top, the date and time are displayed as '2017/07/18 11:27 AM'. Below this, the text 'Input new or registered user ID' is centered. A text input field contains the number '17512215' with a character count '8/16' on the right. Below the input field is a dark button labeled 'OK'. At the bottom, there are two icons: a gear icon labeled 'Settings' and a clipboard icon labeled 'Measurement'.

NOTE: If ID exists, user will be brought to this screen for verification. If changes are needed, please press on the information to be edited. Once all information is correct, press Confirm to proceed.

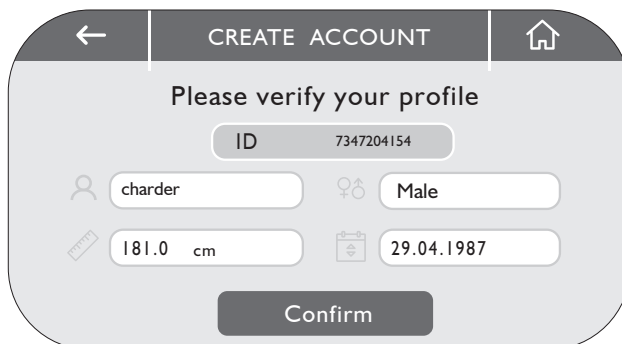

A screenshot of a mobile application interface titled 'CREATE ACCOUNT'. The screen displays 'Please verify your profile'. The ID '7347204154' is shown in a grey box. Below the ID, there are four input fields: 'charder' (with a person icon), 'Male' (with a male icon), '181.0 cm' (with a ruler icon), and '29.04.1987' (with a calendar icon). A dark button labeled 'Confirm' is at the bottom.

2. If creating a new account, user can enter name using on-screen keyboard and physical buttons. Press Next> to proceed.

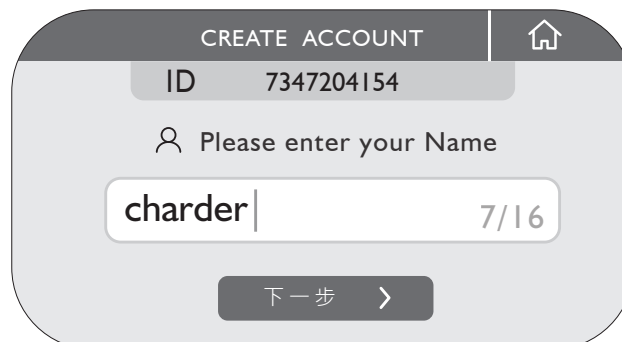

A screenshot of a mobile application interface titled 'CREATE ACCOUNT'. The ID '7347204154' is shown in a grey box. Below the ID, the text 'Please enter your Name' is displayed with a person icon. A text input field contains the name 'charder' with a character count '7/16' on the right. Below the input field is a dark button labeled '下一步 >' (Next Step >).

VII. MEASURING INSTRUCTIONS

D. Measuring Procedure

3. Enter height.

After entering height, press **Next** > to proceed.

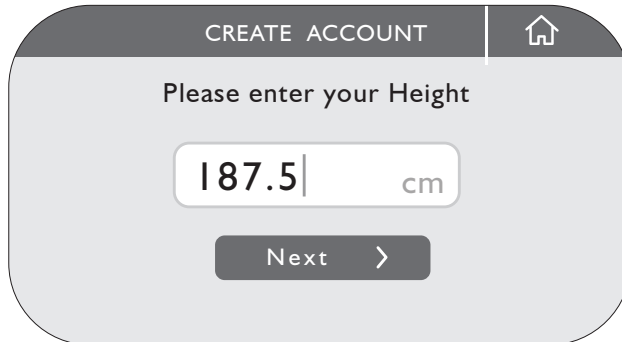

The screenshot shows a mobile application interface for creating an account. At the top, there is a dark header with the text "CREATE ACCOUNT" and a home icon on the right. Below the header, the text "Please enter your Height" is displayed. A text input field contains the value "187.5" followed by "cm". Below the input field is a dark button with the text "Next" and a right-pointing chevron symbol.

4. Enter birthday.(default order: Year/Month/Day)

After entering your birthday, press **Next** to proceed.



The screenshot shows a mobile application interface for creating an account. At the top, there is a dark header with a back arrow on the left, the text "CREATE ACCOUNT" in the center, and a home icon on the right. Below the header, the text "Please enter your Birthday" is displayed. A text input field contains the value "1992 / 04 / 29". Below the input field is a dark button with the text "Next" and a right-pointing chevron symbol.

5. Select gender.

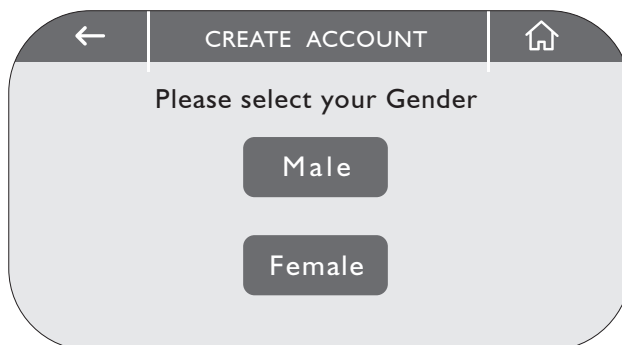

The screenshot shows a mobile application interface for creating an account. At the top, there is a dark header with a back arrow on the left, the text "CREATE ACCOUNT" in the center, and a home icon on the right. Below the header, the text "Please select your Gender" is displayed. There are two dark buttons stacked vertically: the top one contains the text "Male" and the bottom one contains the text "Female".

VII. MEASURING INSTRUCTIONS

6. Verify profile.

If changes are needed, please press on the information to be edited. Once all information is correct, press Confirm to proceed.

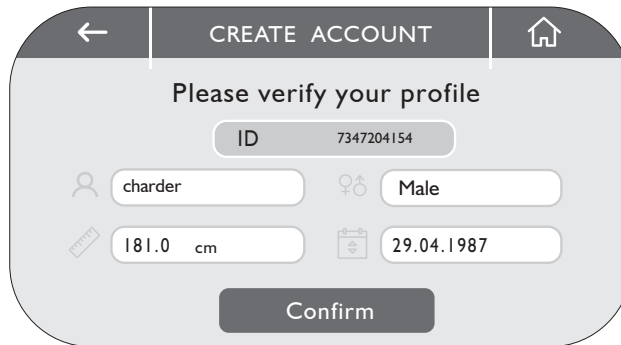

The screenshot shows a mobile application interface for creating an account. At the top, there is a dark header with a back arrow on the left, the text 'CREATE ACCOUNT' in the center, and a home icon on the right. Below the header, the main content area is light gray and contains the text 'Please verify your profile'. The form includes several input fields: 'ID' with the value '7347204154', a name field with 'charder', a gender field with 'Male' and a male icon, a height field with '181.0 cm' and a ruler icon, and a date of birth field with '29.04.1987' and a calendar icon. At the bottom of the form is a dark 'Confirm' button.

Ensure the subject is standing on the measurement platform correctly.

Hands	*Hands should be clean and dry
Feet	*Subject should stand on device with bare feet. *Feet should be clean and dry.
Posture	*Subject should be standing upright. If the subject needs assistance in standing, ensure that assisting staff wears non-conductive clothing where contact is made, to avoid influencing measurement results.

VII. MEASURING INSTRUCTIONS

7. After profile has been verified, subject should step onto the device for weight measurement. To change the clothing weight deduction, press the Clothes Weight button. Avoid moving or speaking while weight is being measuring. Once weight measurement has stabilized, the bold number will flash several times on the screen.



8. Hold the electrode handles.

Place thumb on the thumb electrode, and wrap four fingers around the grip. If subject lets go of the handles during the scanning process, the scan cannot be completed.



9. Stand on foot electrodes.

Please note the soles of the feet should be on the foot electrodes. If the subject steps off of the measuring platform, the scanning process cannot be completed.

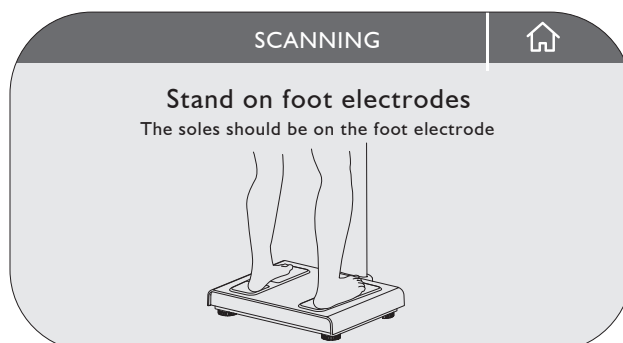

VII. MEASURING INSTRUCTIONS

10. Stretch both arms out.

Do not bend or shake the arms until the measurement completed.

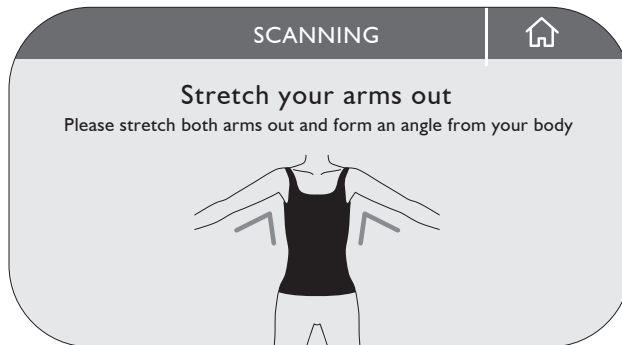

11. The device will confirm if electrodes are in proper contact.

Subject should maintain proper posture and electrode contact.

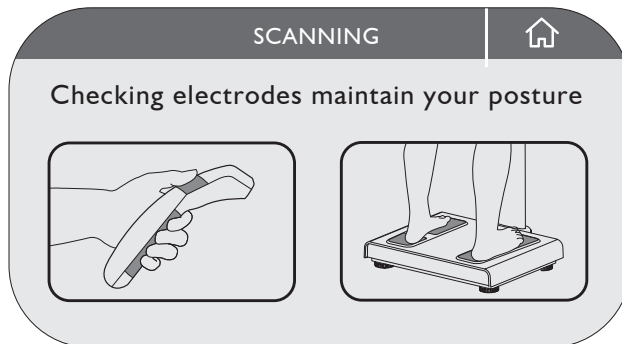

12. The device will automatically confirm if hand electrodes are in contact.

A yellow circle will appear if everything is correct.

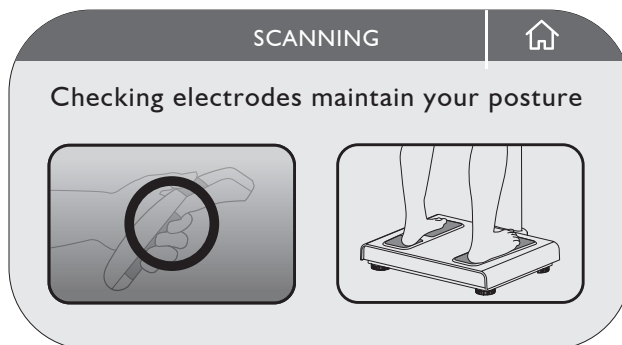

VII. MEASURING INSTRUCTIONS

13. The device will proceed to confirm if foot electrodes are in contact. A yellow circle will appear if everything is correct.

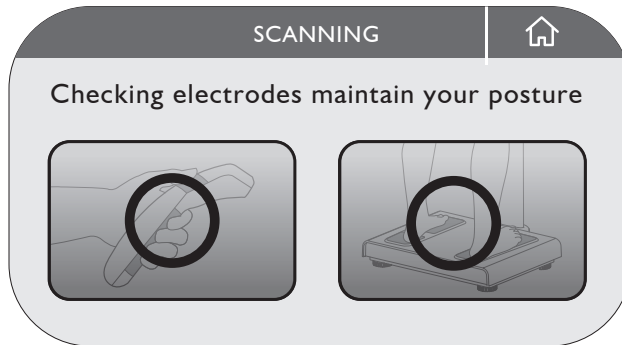

14. The device will begin scanning the subject to analyze body composition. Measurement should be completed in about 45 seconds.

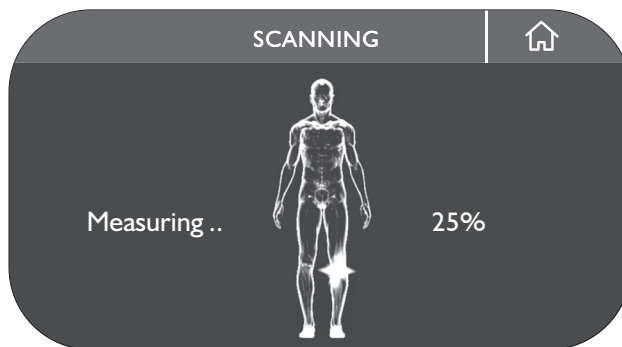

15. After measurement is completed, place hand electrodes back into holders. Basic results will be displayed on the LCD screen when body composition analysis is completed. Press Print Results to print out a completed result sheet.

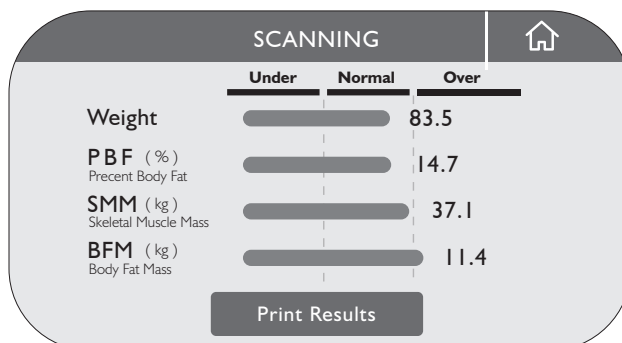

VIII. ABOUT RESULTS

A. Standard Result Sheet

Multiple Result Sheets are available on the MA601 Body Composition Analyzer.
Please consult website for more information regarding non-default options.

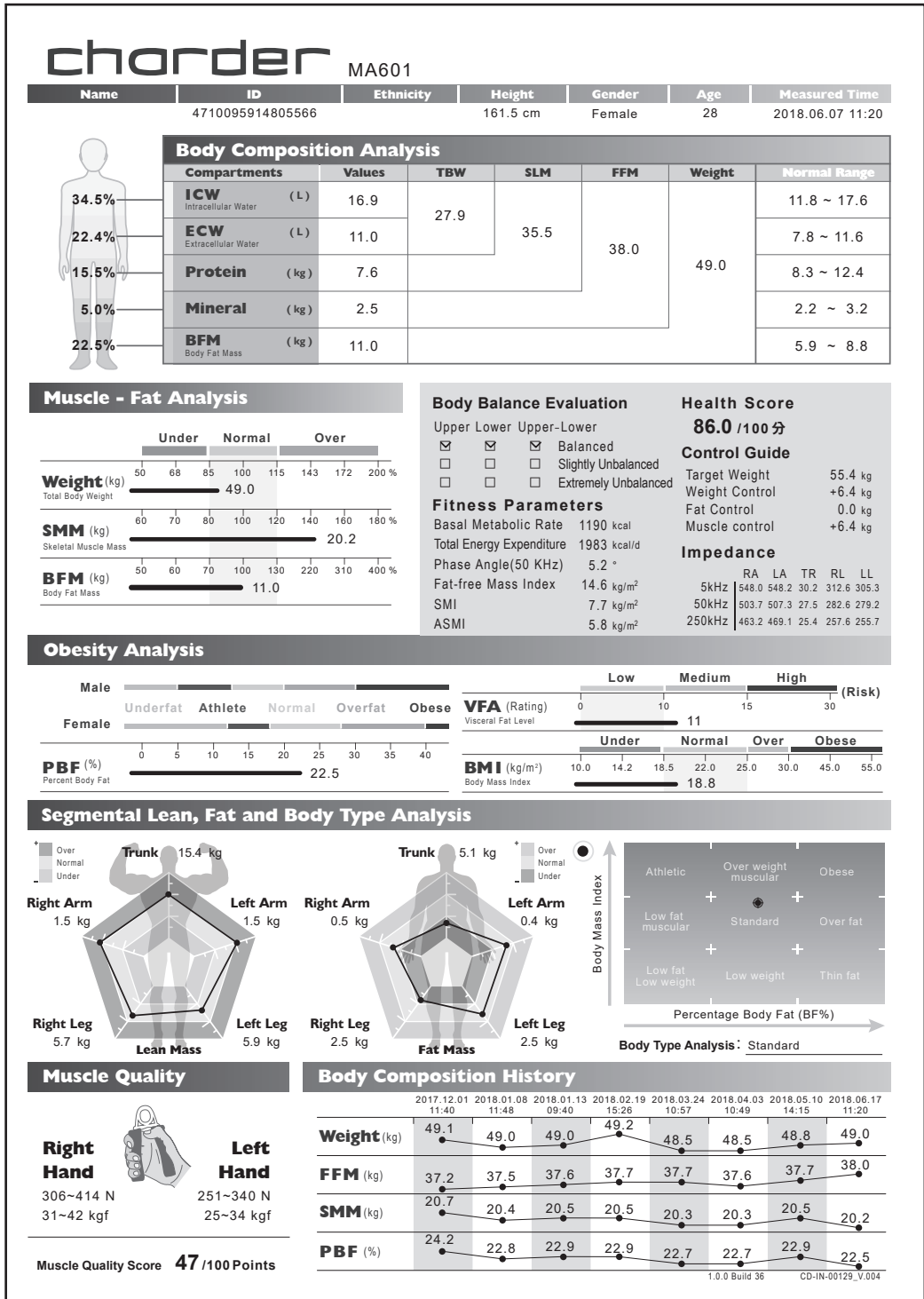

VIII. ABOUT RESULTS

B. Result Sheet Explanation

This section provides an overview of Body Composition and Bioelectrical Impedance Analysis. For additional information, we recommend the study of relevant medical literature.

Body Composition Analysis

The human body is composed of a variety of elements that can be calculated and measured separately using a combination of methods. The MA601 uses a 4-compartment model that divides the body into water, protein, minerals, and fat. Their corresponding measurement techniques can be found below:

Parameters	Measurement Technique
Total Body Water (TBW)	Dilution method. Tracer: Deuterium
Extracellular Water (ECW)	Dilution method. Tracer: Sodium bromide
Protein	Neutron Activation Analysis
Minerals	Dual Energy X-Ray Absorbtiometry (DXA/DEXA)
Fat-Free Mass (FFM)	Difference between weight and fat mass
Fat Mass (FM)	Calculated using the 4-compartment model of Body Composition - Total Body Water, Body Volume, Body Minerals, and Weight

The direct measurement of fat mass in particular is technically complex, requiring the combination of several different parameters. Further details below:

Parameters needed to measure FM	Measurement Technique
Total Body Water (TBW)	Dilution method. Tracer: Deuterium
Body Volume	Densitometry - Underwater Weighing (UWW) or Air Displacement Plethysmography (ADP)
Minerals	Dual Energy X-Ray Absorbtiometry (DXA/DEXA)

Most of the above "gold standard" techniques are time-consuming, and use specialized equipment which require trained medical staff to operate. As such, they tend to be impractical for most facilities.

Bioelectrical Impedance Analysis

The MA601 uses Bioelectrical Impedance Analysis (BIA) to determine body composition. At its core, BIA operates by treating the human body as an electrical conductor within an alternating current circuit, from which the alternating current resistance and impedance is measured.

Using a combination of existing population data and in-house research, body composition analysis formulas can calculate results based on the Impedance, Height, Gender, Age, and Weight of the subject. These formulas are formulated with reference to gold standard measurements such as those listed above to confirm viability and accuracy.

BIA is non-invasive and safe for all subjects, with the exception of people who have embedded electronic medical equipment. The accuracy of BIA can be affected by various environmental and biological factors. For more information on recommended measurement precautions, please refer to Chapter VI. Instructions for Operation

VIII. ABOUT RESULTS

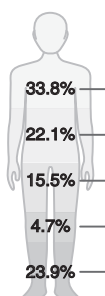

Body Composition Analysis						
Compartments	Values	TBW	SLM	FFM	Weight	Normal Range
33.8% ICW Intracellular Water (L)	16.4	27.1	34.6	36.9	48.5	17.0 ~ 20.8
22.1% ECW Extracellular Water (L)	10.7					10.4 ~ 12.8
15.5% Protein (kg)	7.5	7.4 ~ 9.1				
4.7% Mineral (kg)	2.3	1.6 ~ 2.7				
23.9% BFM Body Fat Mass (kg)	11.6	8.7 ~ 13.6				

Total Body Water, Extracellular Water, and Intracellular Water

Total Body Water (TBW) refers to the water contained in the tissues, blood, bones, and elsewhere. TBW in a healthy (non-obese) adult can fluctuate by roughly 5% daily, influenced by physiological activity and consumption of food and drink⁴. Due to larger size and muscle mass, healthy adult men have more TBW than women (on average)⁵.

For healthy (non-obese) adults, TBW constitutes ~ 60% of body weight and ~ 73% of Fat-Free Mass⁶. However, it is important to note that this percentage is not applicable to children - typically, children have a higher percentage of body water than adults, and TBW levels reportedly decrease further around middle age as part of the aging process⁷. In addition, various diseases can affect body water percentage, including renal deficiency, diabetes, cardiac failure, and cancer⁸. Therefore, BIA estimations should be used with particular caution if subject's body water differs significantly from the representative populations used to formulate BIA algorithms.

TBW can be divided into Intracellular Water (ICW) and Extracellular Water (ECW). ICW:ECW proportion for healthy populations is roughly 3:2 (ECW/TBW= \sim 0.38)⁹. The Edema Index calculates this ratio for usage by professionals.

Soft Lean Mass

Soft Lean Mass is the weight of the body after deducting total fat mass and minerals.
(Weight - Body Fat Mass - Minerals = Soft Lean Mass)

Fat-Free Mass

Fat-Free Mass (FFM) is the weight of the body after deducting total fat mass.
(Weight - Body Fat Mass = Fat-Free Mass)

Protein

This is an estimation of the protein contained in the body.

4. Askew EW Present Knowledge in Nutrition (7th ed) 1996, p.98-107

5. Lesser GT, Markofsky J. Body water compartments with human aging using fat-free mass as the reference standard. 1979. Am J Physiol, 236, p.R215-R220.

6. Wang ZM, Deurenberg P, Wang W, Pietrobelli A, Baumgartner RN, Heymsfield SB. Hydration of fat-free body mass: review and critique of a classic body-composition constant. The American Journal of Clinical Nutrition. 1999. Vol.69 Issue 5, p.833-841.

7. Cameron CW, Guo SS, Zeller CM, Reo NV, Siervogel RM. Total body water for white adults 18 to 64 years of age: The Fels Longitudinal Study. 1999. Kidney International Vol.56 Issue 1, p.244-252

8. Moore FD, Haley HB, Bering EA, Brooks L, Edelman I. Further observations on total body water. Changes of body composition in disease. 1952. Surg Gynecol Obstet, 95, p.155-180

9. Tai R, Ohashi Y, Mizuiuri S, Aikawa A, Saki K. Association between ratio of measured extracellular volume to expected body fluid volume and renal outcomes in patients with chronic kidney disease: a retrospective single-center cohort study. BMC Nephrology, 2014;15:189

VIII. ABOUT RESULTS

Minerals

Body minerals are contained primarily inside bone tissue and the bloodstream.

Weight

The MA601 has a precise built-in scale for weight measurement. During the measurement setup process, users can correct for clothing weight manually.

Body Fat Mass

Body Fat Mass is calculated by subtracting Fat-Free Mass (FFM) from total body weight.

Muscle - Fat Analysis

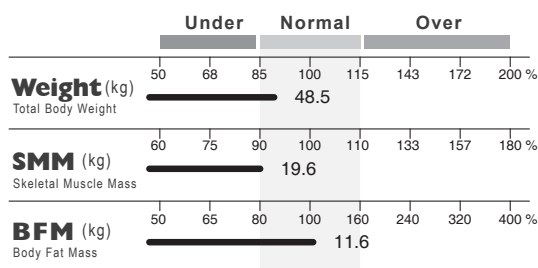

Muscle-Fat Analysis

The length of the black bar indicates the interpretation of the subject's values in comparison with the reference population. If the length of the line falls within the colored area, the subject's values are within normal range. If the length of the line falls to the left or right, then values are below and above normal range.

Weight

Normal range for weight is calculated using Body Mass Index (BMI) standards.

NOTE: for subjects under the age of 18, standard adult BMI may not be as applicable, as children have varying ranges and body shapes in growth. Physicians are recommended to consult height-corrected BMI standards for children.

Skeletal Muscle Mass (SMM)

Cardiac muscle, smooth muscle, and skeletal muscle are the three major muscle types found in the body. Skeletal muscle mass correlates with athletic performance, as it is under voluntary control and used to power movement. In addition, it can be developed actively through proper nutrition and training, thus making this value an important indicator for evaluation of fitness progression. As there currently are no universal cut-off points for skeletal muscle mass, this value is recommended for usage primarily in tracking change over a period of time.

Body Fat Mass (BFM)

This section places the calculated body fat mass value in comparison with normal range.

Body fat can be divided into subcutaneous fat (under the skin) and visceral fat (surrounding the organs). An essential level of fat is required for the body to function, though excessive fat can result in obesity-related diseases.

VIII. ABOUT RESULTS

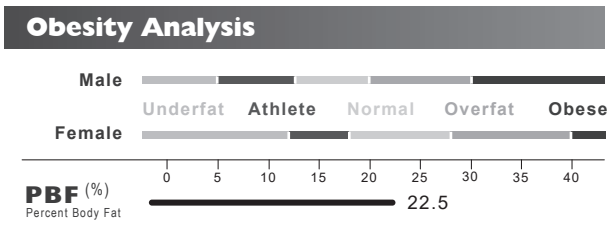

Percent Body Fat

Body fat percentage is useful in determining the specific cause of weight loss or gain. Average percentages differ according to specified groups and categories, most significantly by gender. Although no universally accepted published ranges or cut-off points for body fat percentage currently exist, it is still an important value in assessing change in body composition and health. The MA601 provides different body fat standards for males and females, divided into ranges commonly seen in underfat, athlete, normal, overfat, and obese populations.

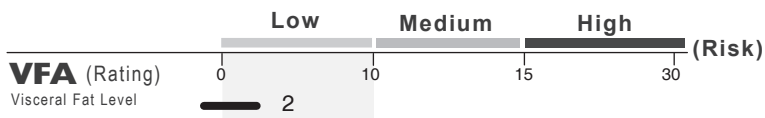

Visceral Fat Level

Visceral obesity can occur even if a subject's weight or BMI is within standards. Such subjects are thin on the outside, but fat on the inside. Visceral fat level is used as an indicator for risk of obesity-related disease, and a level under 10 (low risk) is recommended.

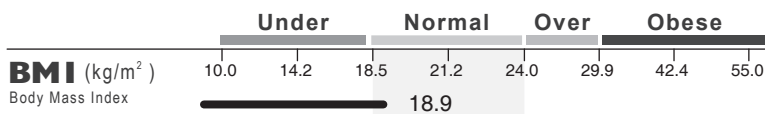

Body Mass Index (BMI)

BMI is a commonly used index by the World Health Organization (WHO), utilizing height and weight to classify underweight, normal, over, and obesity in adults. The definition of "normal range" differs according to gender, age, and ethnicity, as different populations may have different associations between BMI and health risks. Notably, the proportion of Asian populations with risk factors for Type 2 diabetes and cardiovascular disease is substantial even below the WHO international BMI cut-off point of 24.9¹⁰. Accordingly, there are multiple BMI normal range settings available on the MA601 (WHO: 18.5-24.9, Asia: 18-23, Taiwan: 18-24, China: 18-23.9) that can be selected in the System Settings.

NOTE: BMI is calculated purely based on height and weight, and does not distinguish between muscle and fat. As such, it can be potentially misleading, particularly for individuals with higher levels of muscle mass.

10. *Appropriate body-mass index for Asian populations and its implications for policy and intervention strategies. The Lancet, Public Health, Vol. 363, Issue 9403, p.157-163, 2004.*

VIII. ABOUT RESULTS

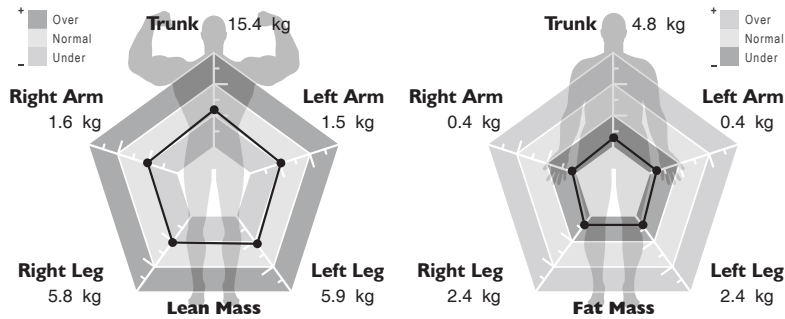

Segmental Lean, Fat, and Body Type Analysis

The MA601 analyzes the lean mass and fat mass for the following body segments: trunk, right arm, left arm, right leg, and left leg. Segmental analysis is important for evaluating progress and identifying imbalance. The marker on the radar chart correlates to the ranges for under, normal, and over for each segment.

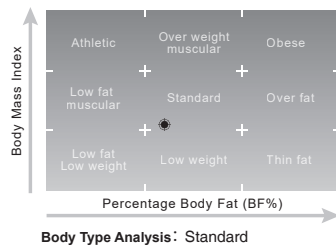

Body Type Analysis

The MA601 combines BMI with Body Fat Percentage to analyze the subject's body type, making it easier to identify the source of body mass, distinguishing between a high BMI caused by higher than average muscle or fat.

Muscle Quality

Right Hand

203 ~ 248 N
21 ~ 25 kgf



Left Hand

183 ~ 224 N
19 ~ 23 kgf

Muscle Quality Score **58** /100 Points

Muscle Quality

Charter's patented analysis algorithms can estimate and score muscle quality in context of the overall population after taking into account muscle mass, age, gender, and other factors¹¹. Grip strength is a general indicator for muscle quality, useful in tracking, evaluation, and improvement of physical fitness programs¹²¹³.

11. KC Hsieh, et al., Evaluation muscle function by using a standing bioelectrical impedance vector analysis, *Plos One*, 2019; Under review.

12. Norman K, et a.. Hand grip strength: outcome predictor and marker of nutritional status. *Clin Nutr.* 2011; 30: 135-142.

13. Rodriguez-Rodriguez F, et al.. Bioelectrical Impedance Vector Analysis and Muscular Fitness in Healthy Men. *Nutrients.* 2016; 8

VIII. ABOUT RESULTS

Body Composition History

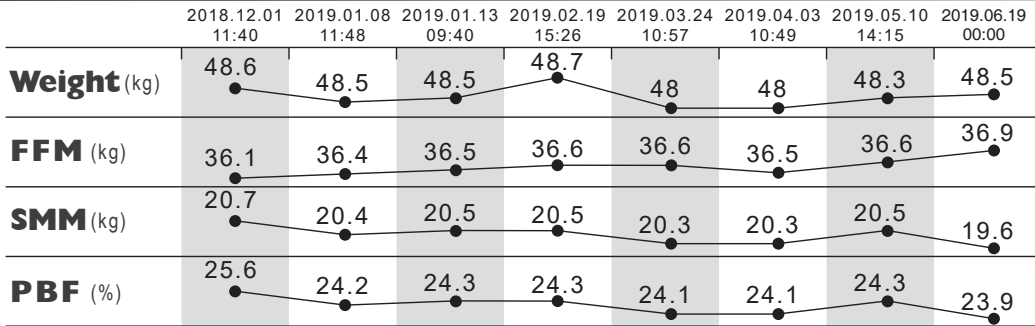

Body Composition History

BIA results are most effectively used in tracking change, If the subject inputs the same ID when conducting measurement, the previous 8 results for Weight, Fat-Free Mass (FFM), Skeletal Muscle Mass (SMM), and Percent Body Fat (PBF) will be displayed on the result sheet.

Body Balance Evaluation

Upper	Lower	Upper-Lower	
<input checked="" type="checkbox"/>	<input checked="" type="checkbox"/>	<input checked="" type="checkbox"/>	Balanced
<input type="checkbox"/>	<input type="checkbox"/>	<input type="checkbox"/>	Slightly Unbalanced
<input type="checkbox"/>	<input type="checkbox"/>	<input type="checkbox"/>	Extremely Unbalanced

Body Balance Evaluation

Imbalances in segmental body mass can increase the risk of injury or posture-related health issues. By calculating differences in mass between the arms, legs, and Upper-Lower body, information regarding balance can provide goals and targets for evaluation..

NOTE:

Overall imbalance in mass is still possible even if the values for segmental lean mass and fat mass are largely identical, due to differences in bone density and overall segmental weight.

VIII. ABOUT RESULTS

Fitness Parameters

Basal Metabolic Rate	1167 kcal
Total Energy Expenditure	1658 kcal/d
Phase Angle (50KHz)	5.6 °
Fat-free Mass Index	14.4 kg/m ²
SMI	7.7 kg/m ²
ASMI	5.8 kg/m ²

Basal Metabolic Rate

Basal Metabolic Rate (BMR) is the minimum required energy to sustain the body's vital functions while at rest. These functions include breathing, blood circulation, regulation of body temperature, cell growth, brain function, and nerve function. BMR tends to decrease with age or reduction in weight, and is positively correlated with increase in muscle. Disease, food intake, changes in temperature, and other factors can all influence a person's energy expenditure and thus BMR¹⁴.

Total Energy Expenditure

Total Energy Expenditure (TEE) is calculated using BMR as a baseline, further taking into account energy used for daily activity, including digestion and physical movement. Subject's actual TEE will vary based on type of activity. The TEE calculated by the MA601 is for a "typical" day without strenuous exercise.

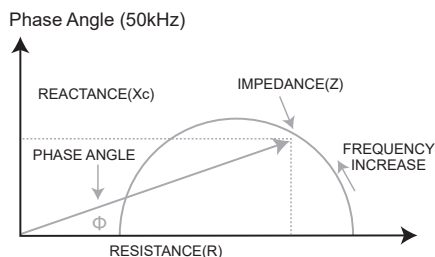

Phase Angle (50kHz)

BIA measures impedance (Z), which is comprised of reactance (Xc) (correlating with cell integrity), and resistance (R) (correlating with the distribution of water within and outside the cell membrane). The angle of the hypotenuse in the triangle drawn using (Z), (Xc), and (R) is the Phase Angle, which is correlated with factors such as age, gender, malnutrition, inflammation, and BMI.

A higher phase angle can be the result of stronger cell membranes, and as such healthier and well-nourished cells. A lower phase angle can be caused by weaker cell membranes. Accordingly, phase angle can be used as a potential health indicator.

Generally speaking, subjects with stronger (and thus healthier) cell membrane have higher reactance and lower resistance, leading to a higher phase angle. However, because phase angle is also affected by factors such as age, height, ethnicity, gender, disease, measuring posture, and measurement device¹⁵, it is recommended for usage in tracking change of an individual subject, rather than a one-time measurement.

14. Lazzer, S. , Bedogni, G. , Laforluna, C. L., Marazzi, N. , Busti, C. , Galli, R. , Col, A. , Agosti, F. and Sartorio, A. (2010), *Relationship Between Basal Metabolic Rate, Gender, Age, and Body Composition in 8,780 White Obese Subjects. Obesity*, 18: 71-78

15. Stobaus N, Pirlich M, Valentini L, Schulzke J D. Determinants of bioelectrical phase angle in disease. *British Journal of Nutrition*. Vol.107, Issue 8, p.1217-1220.

VIII. ABOUT RESULTS

Fat-free Mass Index and Skeletal Muscle Index

$$\text{BMI} = \frac{\text{total body weight}}{\text{height}^2} \left(\frac{\text{kg}}{\text{m}^2} \right)$$

$$\text{FFMI} = \frac{\text{fat-free mass}}{\text{height}^2} \left(\frac{\text{kg}}{\text{m}^2} \right)$$

$$\text{SMI} = \frac{\text{skeletal muscle mass}}{\text{height}^2} \left(\frac{\text{kg}}{\text{m}^2} \right)$$

$$\text{ASMI} = \frac{\text{appendicular skeletal muscle mass}}{\text{height}^2} \left(\frac{\text{kg}}{\text{m}^2} \right)$$

The Fat-free Mass Index (FFMI), Skeletal Muscle Index (SMI), and Appendicular Skeletal Muscle Index (ASMI) is an equivalent concept to BMI, but using fat-free mass, skeletal muscle mass, or appendicular skeletal muscle mass (weight of the limb muscles) rather than total weight mass. This makes it possible to determine body type, and the source of weight.

Fat-free Mass is the weight of the body after fat mass has been subtracted, and includes Skeletal Muscle Mass. An increase in SMM (muscle gains) will cause an increase in FFM. However, the opposite isn't necessarily true - an increase in FFM is not necessarily due to muscle. One major reason for this is because a significant portion of FFM is water.

Cut-off points for risk of sarcopenia:

Various literature is available regarding the definition of cut-off points, but no universal standards exist. Cut-off points can vary based on age and ethnicity. As a guideline though, the following cut-off points can be considered for reference as indicators of lower than normal fat-free mass and skeletal muscle mass:

FFMI: <16.7kg/m² (men) and <14.6kg/m² (women)¹⁶

SMI: < 8.5kg/m² (men) and < 5.75kg/m²(women)¹⁷

ASMI: < 7.0kg/m² (men) and < 5.7kg/m²(women)

16. Schutz Y, Kyle UU, Pichard C. Fat-free mass index and fat mass index percentiles in caucasians aged 18-98 y. *Int J Obes Relat Metab Disord J Int Assoc Study Obes.* 2002;26(7):953-960

17. Janssen I, Baumgartner R, Ross R, Rosenberg IH, Roubenoff R. Skeletal Muscle Cutpoints Associated with Elevated Physical Disability Risk in Older Men and Women, *Am J Epidemiol*, 2004;159:413-41

VIII. ABOUT RESULTS

Health Score

73.3 /100Points

Health Score

The Health Score is calculated through an overall evaluation including fat mass index, fat-free mass index, skeletal muscle index, phase angle, and percentage body fat. In general, increasing muscle and decreasing fat will improve the health score.

Control Guide

Target Control	52.9	kg
Weight Control	+4.4	kg
Fat Control	-0.4	kg
Muscle Control	+4.8	kg

Target Weight

The weight target is based off the normal weight range, taking into account height, age, gender, and ethnicity.

Weight Control

The recommended amount of overall weight to be gained or lost, according to the difference between measured weight and Target Control Weight. The (+) and (-) signs refer to an increase or decrease, respectively. It is possible for the MA601 to recommend changes in Fat and Muscle even if subject is at ideal Target Control Weight, if subject's body fat mass is above the ideal level.

Fat Control

The recommended amount of fat to be lost, calculated with reference to Target Control Weight and body fat mass.

Muscle Control

The recommended amount of muscle to be gained, according to target weight.

Impedance

	RA	LA	TR	RL	LL
5kHz	466.8	468.6	30.6	298.6	288.8
50kHz	428.9	437.4	23.6	275.7	267.1
250kHz	388.6	408.5	18.8	255.6	247.4

Impedance

The MA601 measures the impedance for the right arm (RA), left arm (LA), trunk (TR), right leg (RL), and left leg (LL) using 3 different frequencies.

IX. SYSTEM SETTINGS

A. About System Settings

Press [Settings] button on the screen

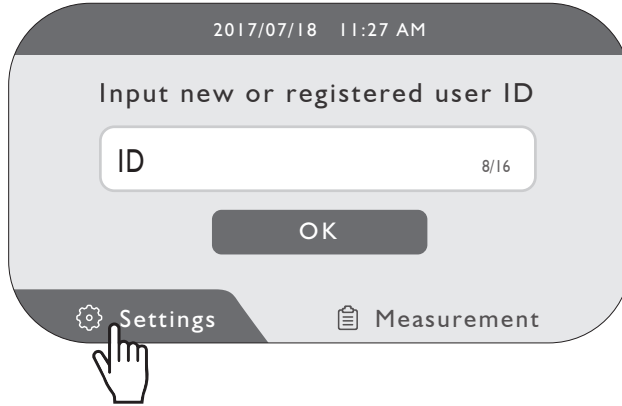

Input the password [default password: 0000] to access the Settings menu

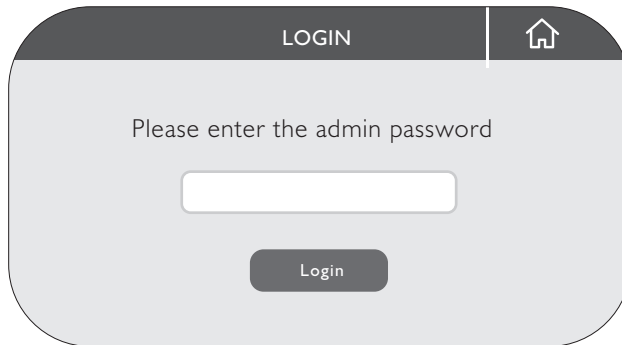



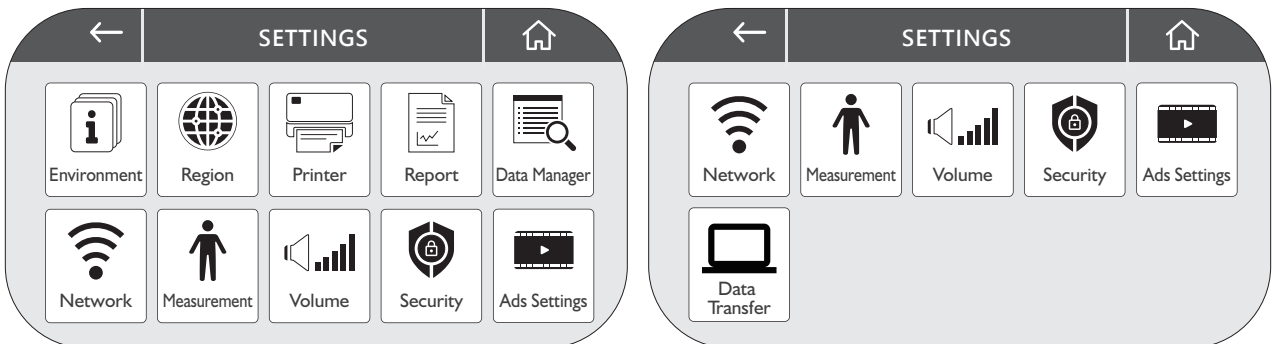







The Settings menu gives access to system setting and tweaks



IX.SYSTEM SETTINGS

System setting instructions

Icon	Mode	Description
 Environment	Environment	Software version, IP address, network, serial number and storage usage
 Region	Region	Time zone, date and time and system language
 Printer	Printer	Printer setup, changing print options, and paper alignment
 Report	Report	Result sheet type selection, setting BMI standards, result sheet format (print with or without background), select image or text to be used on result sheet
 Data Manager	Data manager	Management of measurement results. Search, delete, print, and output results data
 Network	Network	Manage WiFi or Ethernet functions
 Measurement	Measurement	Default measurement ethnicity, clothing weight adjustment, and measurement system (metric, imperial).
 Volume	Volume	Set system volume
 Security	Security	Set and change password required entering the [Settings] menu
 Ads Settings	Ads Settings	Ads contents and time settings.
 Data Transfer	Data Transfer	Adjust data transfer settings, including what results to transfer

IX.SYSTEM SETTINGS



You can find storage space usage here.



Network status, IP address, and MAC address

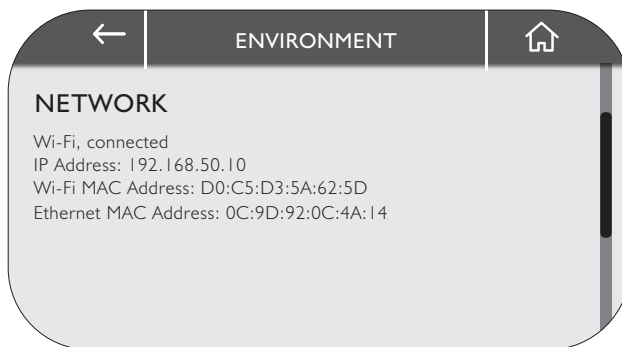

System software version, hardware version, and serial number of this device



IX.SYSTEM SETTINGS



Change date, time and time zone

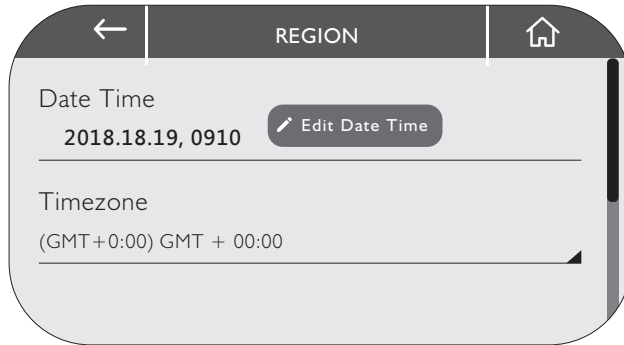

Change date format, time format, and system language

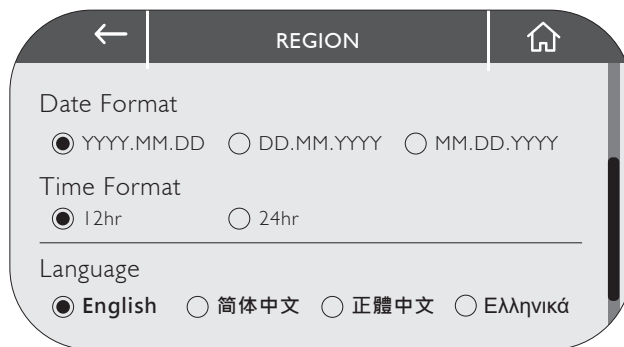

IX.SYSTEM SETTINGS

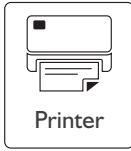

Search for printer, change printer options, and adjust print quality

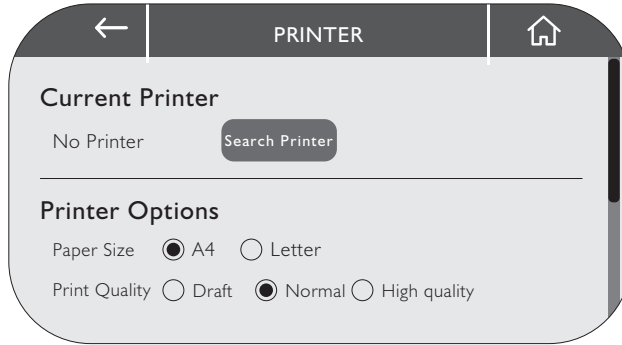

Change paper alignment

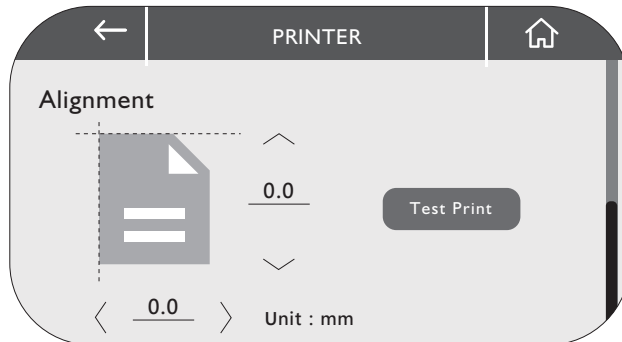

IX.SYSTEM SETTINGS

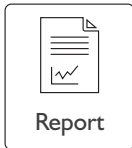

Default Result Sheet

To use Child Result Sheet, check "Child Age Range" checkbox, and select applicable age range to determine when Child Result Sheet will be used. Leave box unchecked to use default Result Sheet for all ages.

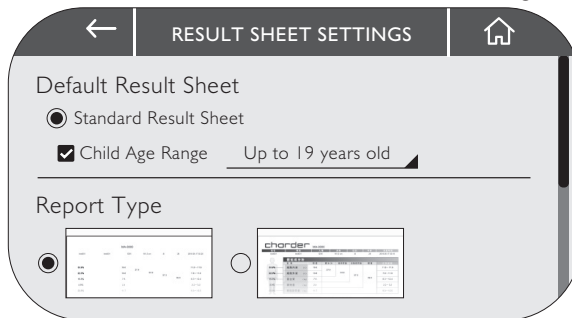

Report Type

Select whether to print result sheet using report paper or blank paper. If using Charder result sheets, "Report Paper" should be selected. If printing onto blank paper, "Blank Paper" should be selected.

BMI Standard

Select BMI normal range most applicable to device usage location:

WHO: 18.5-24.9 kg/m² Asian: 18.5-23 kg/m²

Taiwan: 18.5-24 kg/m² China: 18.5-23.9 kg/m²

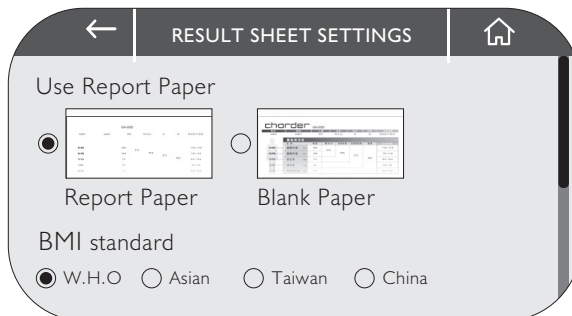

Company Logo

Custom logos can be inserted into the result sheet by plugging a USB drive into the MA601 and pressing the **[Search image]** button. Choose the image from the USB drive and press **[OK]** to confirm.

 Supported image formats: JPG, PNG, and BMP (recommended size: 1982x316 pixels)



IX.SYSTEM SETTINGS



Measurement results are sorted by date. Search can be filtered by user ID or name. Results can be deleted, printed, or exported to USB drive.

DATA MANAGER Test Date: 13.02.2020~16.03.2020

SEARCH DELETED EXPORT Total 9 rows

Select	Print	Delete	Measurement number	User ID	Measurement Date and Time
<input type="checkbox"/>			1	94531267 John	10.03.2020 12:23
<input type="checkbox"/>			2	75773218 Jane	28.02.2020 14:37
<input type="checkbox"/>			3	57052612 A.J	15.01.2020 14:57

Callouts:

- To filter results, input desired ID or name here, and press SEARCH
- Select individual result(s)
- Print result(s)
- Delete result(s)
- Measurement number
- User ID
- To filter results by measurement date, press here. Pop-up calendar (Fig.1) allows you to select date. After selecting desired data range, press SEARCH
- To see basic measurement results, press here (Fig.2)

Fig 1: Pop-up calendar

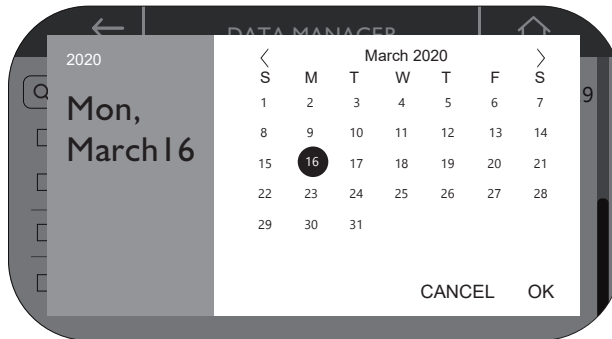
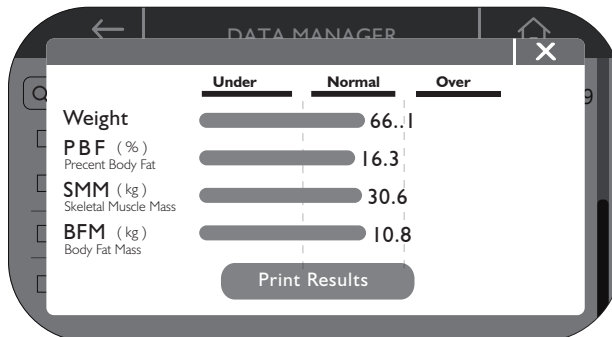

Fig 2. Basic Body Composition Analysis Results



IX.SYSTEM SETTINGS



Wi-Fi functionality can be turned ON or OFF. Scan the network and choose which Wi-Fi SSID network to connect to.

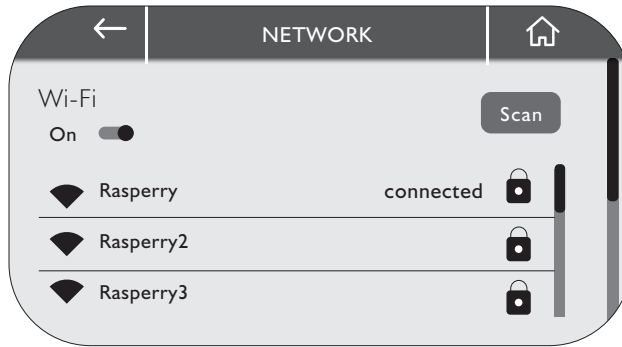

Ethernet functionality can be turned ON or OFF. DHCP functionality can be enabled.

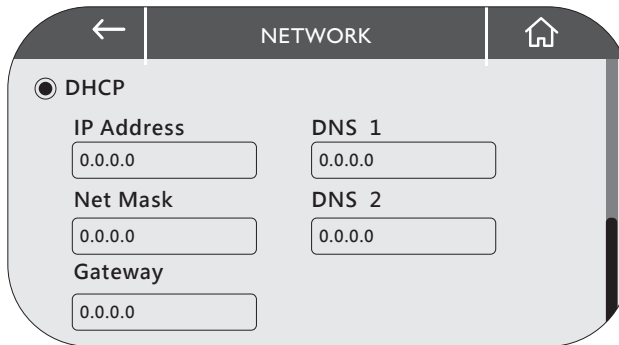

IX.SYSTEM SETTINGS



Default measurement ethnicity, clothing weight adjustment, and measurement system (metric, imperial) can be adjusted here.

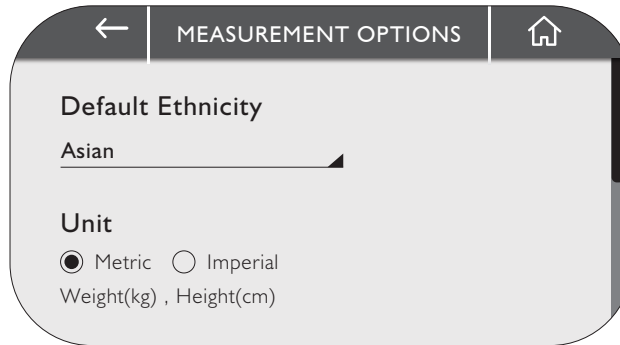

IX.SYSTEM SETTINGS

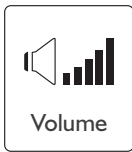

Adjust audio level.

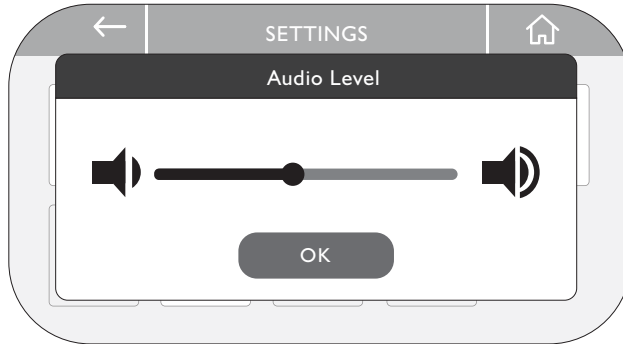

The password required to enter [Settings] can be modified here.

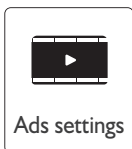

Enable or disable ads mode here. Adjust idle time and media played during ads here.

Accepted file formats: MP4

Resolution: 800x480

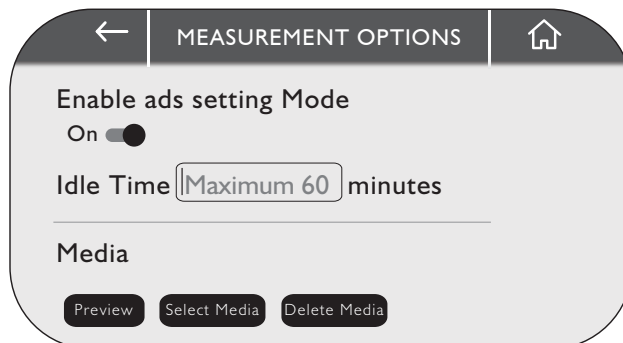

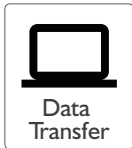

Adjust data transfer settings

Data transfer method

No transfer (print only): Enabled by default. Select this option if device is not connected to PC for transfer of measurement results

PC transfer: Select this option if device is connected to PC for transfer of measurement results

Transfer file format

CSV: only the CSV file containing measurement data (no result sheet) will be transferred

PDF result sheet (without background): data will be organized in result sheet format without the background for quicker data transfer

Transfer all: transfer all measurement data (CSV & PDF) to PC

Confirm user data before measurement

When user data is sent to device via PC to begin measurement

Yes: User/operator must press "Confirm" to begin measurement

No: Device will go directly to measurement procedure without confirmation screen

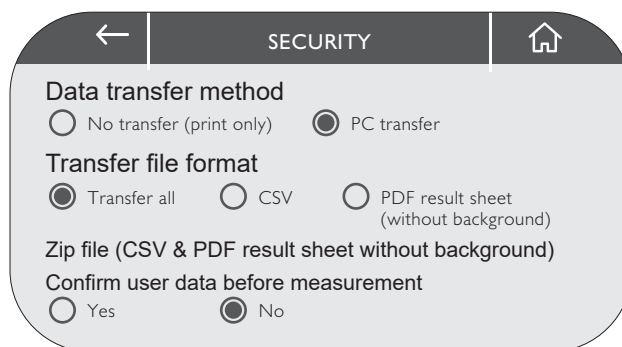

X. PRINTING

A. Printer Compatibility



NOTE: To print Result Sheets, the device needs to be connected to a compatible printer. The device is compatible with Printer Support PCL 5 or above.

NOTE: The device may not recognize other printers. Please confirm PCL 5 compatibility when selecting printer.

B. Connecting Printer

A completed result sheet can be printed out on A4 or Letter-sized paper.

1. Power cable needs to be plugged into the mains.

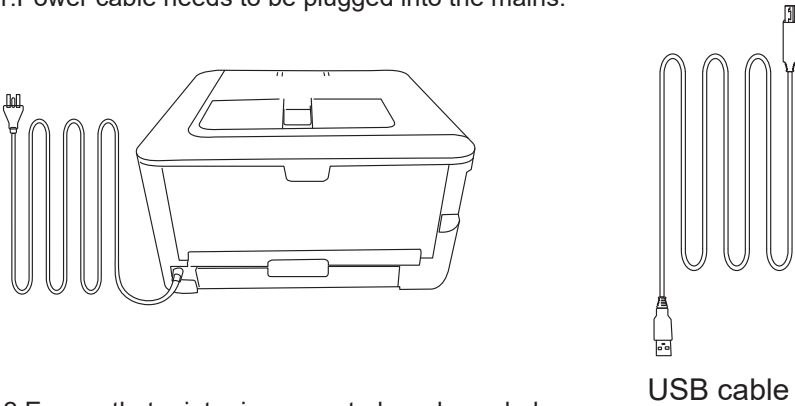

2. Ensure that printer is connected as shown below:

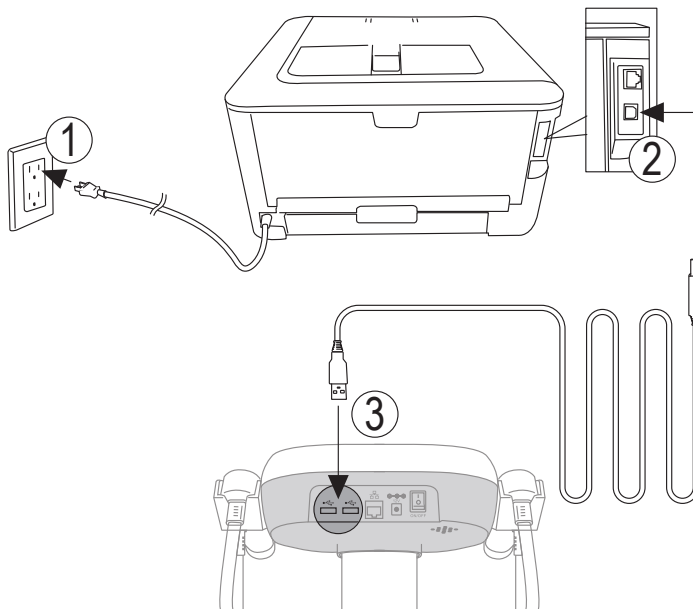

C. Configure Printer Settings in the device

1. Press [Settings] on the screen

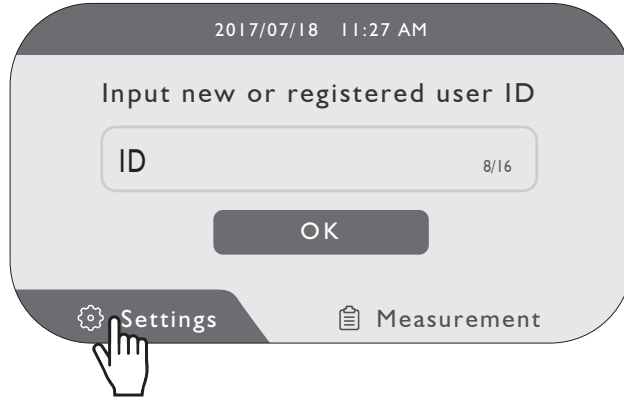

2. Input the password [default password: 0000] to access the Settings menu

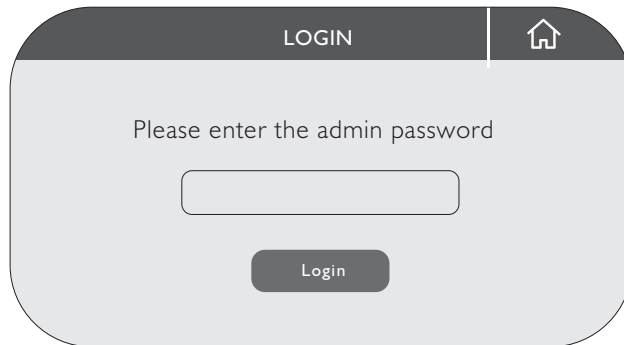

3. Press  to search and set up printer

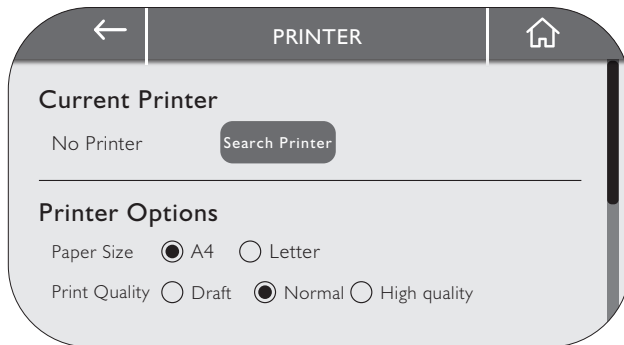

X. PRINTING

4. Press [**Search Printer**] to search printer currently connected to the MA601.

If printer has PCL5 compatibility, then it can be searched and assigned.

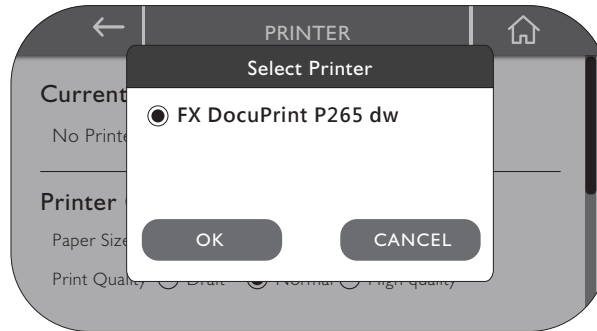

 (printer model above is an example only)

Press [**OK**] to confirm selected printer

5. Missing Printer Driver



If the error message below occurs the first time you install printer drivers, please turn on Wi-Fi function and connect to the internet. After doing so, press [**Search Printer**] again. The device will automatically download and install the correct printer drivers.

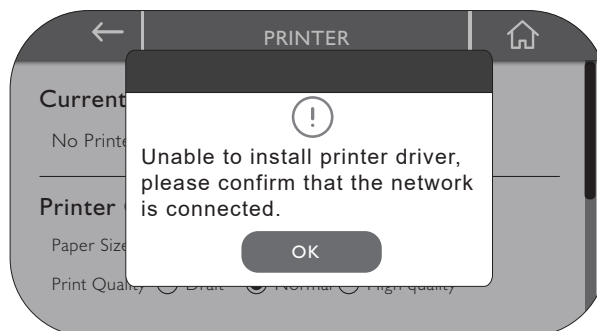

XI. TROUBLESHOOTING

Error	Possible Cause	Suggested action
Insufficient electrode contact	<ul style="list-style-type: none"> - Thumb, fingers or sole did not contact electrodes properly. - The skin is too dry or calloused, interfering with electric current. - Subject's resistance is out of range. 	<ul style="list-style-type: none"> - Clean the electrodes and try again. - Check if your thumb, four fingers fully cover hand electrodes and your soles are on foot electrodes. (consult detailed posture instructions)
Incorrect weight	<ul style="list-style-type: none"> - Scale did not set to zero properly. - Scale did not calibrate properly. 	<ul style="list-style-type: none"> - Go to setting menu to set platform to zero. - Re-calibrate the Body Composition Analyzer. - Check if adjustable feet are stable under the platform.
Measuring result is out of range	<ul style="list-style-type: none"> - Subject's height is out of range. - Subject's weight is out of range. 	<ul style="list-style-type: none"> - Input correct height during measurement. - Make sure weight on the platform is within specification during measurement.
Weight cannot be measured	<ul style="list-style-type: none"> - Weight sensor isn't receiving signal. 	<ul style="list-style-type: none"> - Check if the connector on cable of weight sensor is fully connected. - Check if there is any damage to the cable of weight sensor.
Measuring error	<ul style="list-style-type: none"> - Subject is not on the platform - Cannot detect resistance from electrodes. - Change in weight 	<ul style="list-style-type: none"> - Have subject step onto platform again. - Hold the hand electrodes and stand on foot electrodes the measurement will start again. - Restart the measurement, starting from the weighing process.
Printing error	<ul style="list-style-type: none"> - Unable to communicate with printer 	<ul style="list-style-type: none"> - Connect printer and power on the printer wait for a minute until printer is ready, then press print button again. - Reset printer in system settings by going into printer settings, searching for printer, choosing printer, and saving settings.
Printing shifting	<ul style="list-style-type: none"> - Result sheet is misaligned 	<ul style="list-style-type: none"> - Each batch of result sheets may be slightly shifted. Different printers have different printing areas. To get the most accurate measuring results, please refer to printer settings to set the margin shift correctly.

XII. FREQUENTLY ASKED QUESTIONS(FAQ)

A. Regarding Bioelectrical Impedance Analysis

If you have any questions about the MA601 relating to scientific basis not addressed in the FAQ, please contact us at the following E-mail address: info_cec@charder.com.tw

1. How are Body Composition results measured?

Bioelectrical Impedance Analysis (BIA) is a non-invasive measurement of body composition, based on the fact that the human body consists of conductors and non-conductors. Water (which comprises a significant proportion of muscle) is a good conductor of electricity, where fat is a non-conductor. A small, safe, electric current (AC) is sent through the subject's body. It measures the different levels of resistance (impedance) as it passes through different types of body tissue. These impedance values are then translated using clinically validated algorithms into estimations of water, protein minerals, muscle, and fat. With multiple frequencies, more detailed information - such as water inside and outside cells - can be analyzed. Each BIA device and brand uses a different set of algorithms, which is why measurement results may differ when using different devices.

The most common validation of accuracy is with DXA, though other methods such as MRI and CT are used in some studies. The most appropriate validation standard depends upon what type of composition is measured.

2. Is BIA safe for everyone?

Individuals with implanted medical devices such as pacemakers, defibrillators, or other internal medical devices should not use BIA machines. A low level electrical current is sent through the body during measurement, which may have a potentially disruptive effect on the implanted device.

In addition, BIA measurements can be conducted for the following populations, but there may be difficulties in measurement and drop in result accuracy:

- Individuals that are outside the permissible range of measurements (above 300kg) may receive less accurate results, due to insufficient research data.
- Women undergo a wide range of body composition changes during pregnancy, including but not limited to change in fat percentage and body water, which can affect the accuracy of BIA results.
- Individuals who cannot hold onto the hand electrodes during testing may find it difficult to complete measurements.
- Individuals with prosthetics/amputations cannot complete measurements, as BIA requires contact with all 8 electrodes (2 for each hand and 2 for each foot).

XII. FREQUENTLY ASKED QUESTIONS(FAQ)

- Individuals with embedded metal may receive inaccurate results, as BIA may interpret highly conductive metal as body water, affecting results.

3. Is the electric current harmful to the body ?

Aside from users with implanted medical device, no scientific research has been published cautioning against bioelectrical impedance analysis. In fact, there are proven studies confirming the safety of BIA for the human body. “Bioelectrical impedance analysis (BIA) is a technique that has proven to be safe, generally acceptable to patients, and easy to use [109,110]. (Nutritional Management of Renal Disease, 2013)”

4. Can I wear jewelry, watches, or other metallic ornaments during measurement?

Metal objects may interfere with the electrical current used during testing, affecting measurement accuracy. In addition, heavy clothing or accessories (if not corrected for on the weighing screen) will affect the body composition analysis results, as the weight will be interpreted as body weight.

5. How often should I perform body composition tests?

Changes in body composition from physical training - such as reduced fat mass and increased fat-free mass - are not immediate. For effective tracking of progress, we recommend measuring body composition at least once every two to four weeks.

6. How can I get the most accurate results?

For best results, Body Composition Analysis should be conducted under the same conditions every time. Inconsistent measuring conditions will affect the accuracy and validity of BIA results, as the distribution of body fluids can influence the body's impedance and reactance. Before measurement, please take note of the following:

- Avoid exercise or strenuous physical tasks 12 hours before measurement.
- Avoid eating before measurement. Allow 2 hours for digestion.
- Avoid alcohol 12 hours before measurement.
- Use the bathroom before measurement.
- Take off metallic ornaments and jewelry before measurement.
- Clean hand and foot electrodes before measurement.
- Remove shoes and socks before measurement.
- Avoid excessively tight clothing that may interfere with blood circulation.
- Avoid physical contact with other people or objects during measurement.

XII. FREQUENTLY ASKED QUESTIONS(FAQ)

- Avoid talking, and try to hold still as possible during measurement.
- Perform the measurement in the morning.
- Perform the measurement under normal temperature conditions (24-28°C).

7. The measurement results seem incorrect?

Body composition varies throughout the day, and results are often affected by water distribution, especially strenuous physical activities that may change water distribution in your body. Make sure that you have followed all the steps in Question 6 above before and during measurement.

If results appear noticeably different from a previous measurement or other body composition measurements (such as DXA or Air Displacement Plethysmography), please check the Impedance values. If the impedance difference between the subject's left and right arms (or legs) is significant, it is likely a measurement error has occurred. Please conduct another measurement.

XIII. PRODUCT SPECIFICATIONS

Measurement method	Multi-frequency Bioelectrical Impedance Analysis
Electrodes	Eight electrodes
Frequency	Three frequencies
Frequency range	5 kHz, 50 kHz, 250 kHz
Display	800 x 480 pixels, 7 inch Wide color LCD
Capacity	300 kg
Graduation	0.1 kg
Accuracy	Impedance \pm 3%
Applicable age	6 ~ 85 years old
Input device	Touch screen, Key pad
Output device	USB x 2 Note: Device should be connected to network by qualified distributors only.
Transmission device	Wi-Fi x 1, RJ45 Ethernet x 1, Bluetooth x 1 (optional) Note: Device should be connected to network by qualified distributors only.
Dimensions	580(L) x450(W) x 1025(H) mm
Weight	About 12 kg
Measuring time	Less than 45 secs
Outputs (Standard Body Composition Result Sheet)	<p>Body Composition Analysis ICW, ECW, TBW, Protein, Mineral, BFM, SLM, FFM, Weight</p> <p>Muscle – Fat Analysis : Weight, SMM, BFM</p> <p>Obesity Analysis : BMI, PBF, Visceral Fat Level</p> <p>Segmental Lean & Fat Analysis Lean Mass (Right Arm, Left Arm, Trunk, Right Leg, Left Leg) Fat Mass (Right Arm, Left Arm, Trunk, Right Leg, Left Leg)</p> <p>Body Type Analysis / Muscle Quality Right hand strength, Left hand strength, Muscle quality score</p> <p>Fitness Parameters Body Balance Evaluation, Basal Metabolic Rate, Total Energy Expenditure, Phase Angle, Fat-free Mass Index, Skeletal Muscle Index, Appendicular Skeletal Muscle Index, Impedance</p> <p>Health Score / Control Guide Target Weight, Weight Control, Fat Control, Muscle Control</p> <p>Body Composition History : Weight, FFM, SMM, PBF</p>
Electrode Current	< 500 μ A
Power supply	Input AC 100~240V, 50/60Hz, 0.8 ~ 1.5 A Output DC 12V, 5A adapter
Printing device	USB port
Measuring range	100 ~ 950 Ω
Operation environment	50 ~ 104°F (10 ~ 40°C), 30 ~ 75% RH, 70 ~ 106 kPa
Voice guidance	Voice guidance throughout entire measuring process
Results sheet	Standard, Child (A4 or Letter size)

* For purpose of product improvement, specifications are subject to change without prior notice.

Declaration of Conformity

Manufacturer hereby declares that this product is in conformity with the regulations and standards outlined in the following directives:

	93/42/EEC as amended by 2007/47/EC Medical Device Directive
---	--

RoHS Directive 2011/65/EU and Delegated Directive (EU) 2015/863

Radio equipment and telecommunications terminal equipment Directive 2014/53/EU

(applicable if wireless module is used)

Authorized EU Representative:



Obelis s.a.
Bd Général Wahis, 53
B-1030 Brussels
Belgium



Charder Electronic Co., Ltd.
No.103, Guozhong Rd., Dali Dist., Taichung City 41262 Taiwan
TEL: +886 4 2406 3766 FAX: +886 4 2406 5612
Email: info_cec@charder.com.tw www.chardermedical.com